

Galpón / Garaje de metal

MANUAL DE USUARIO

Instrucciones de montaje de modelo BETA 18

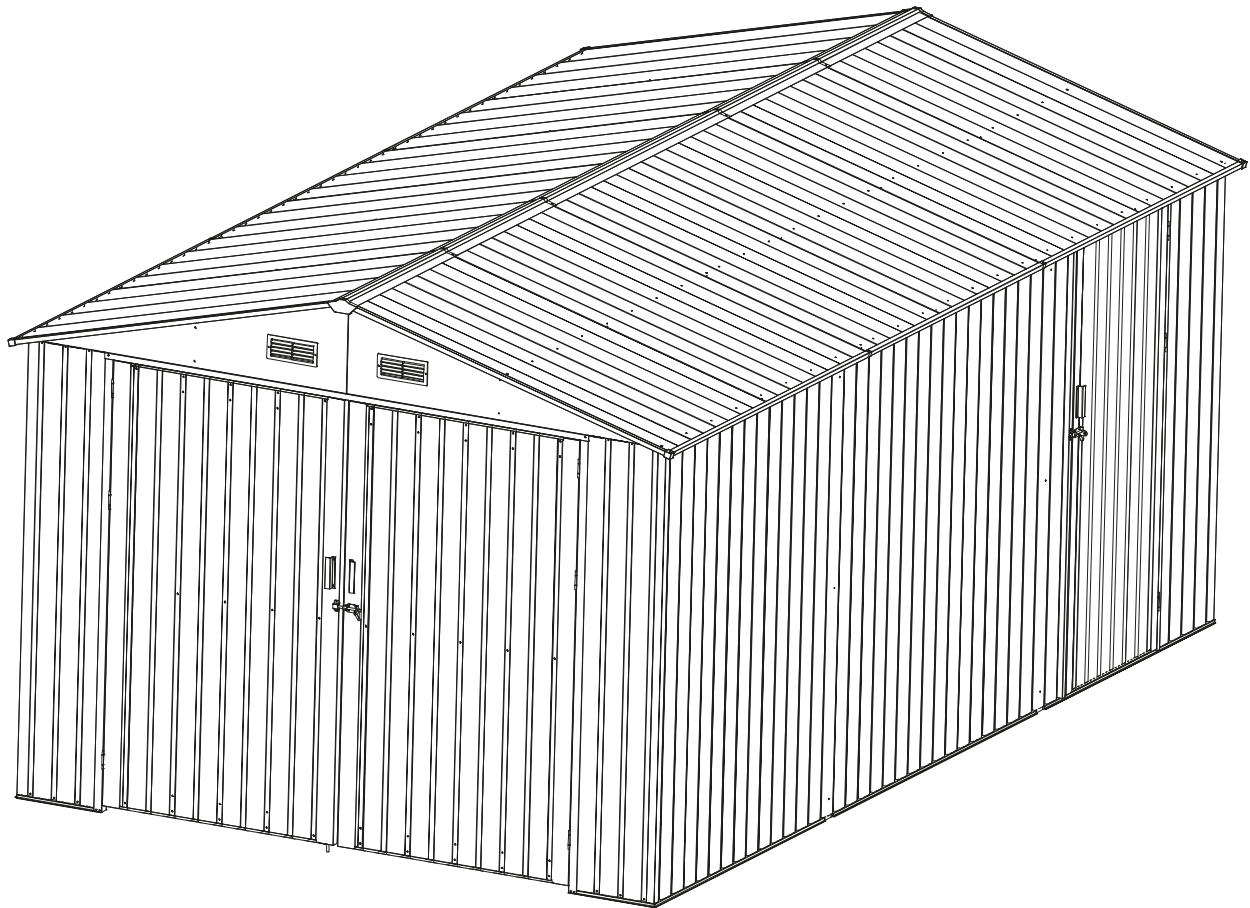

CARACTERÍSTICAS:

Modelo: GARAJE BETA 18

- Dimensiones generales: L602 × W300 × H232 cm
- Altura de la pared: 190 CM, Dimensiones de la base: L590 × W290 cm
- Material: marco de acero galvanizado de 0,6 mm-1,0 mm de espesor
- Hoja de revestimiento de acero galvanizado de 0,25 mm para techo y pared
- Características: diseño de techo Apex con 4 salidas de aire
- Puertas delanteras con bisagras dobles; Dimensiones de la puerta Al. 186 × An. 212 cm
- Puerta con bisagra simple lateral grande; Dimensiones de la puerta Al. 186 × An. 78 cm
- Ambas puertas aseguradas con casilleros y llaves de buena calidad
- Marco de techo completo y refuerzos de pared incluidos para una mejor estabilidad
- Kits de anclaje interior incluidos para una mejor resistencia al viento.

ANTES DE EMPEZAR

Estudiar y analizar este manual es importante.

Su construcción será más fácil si se lee la información importante y los consejos útiles.

IMPORTANTE:

- Revisar todas las instrucciones antes de comenzar.
- Durante el armado, siga los pasos cuidadosamente para obtener resultados correctos.

Partes

Verifique que tenga todas las piezas necesarias para su armado.

Separe el contenido de la caja por el número de pieza mientras revisa la lista.

Tener presente que se han colocado tornillos adicionales para su comodidad.

LAS HERRAMIENTAS NECESARIAS:

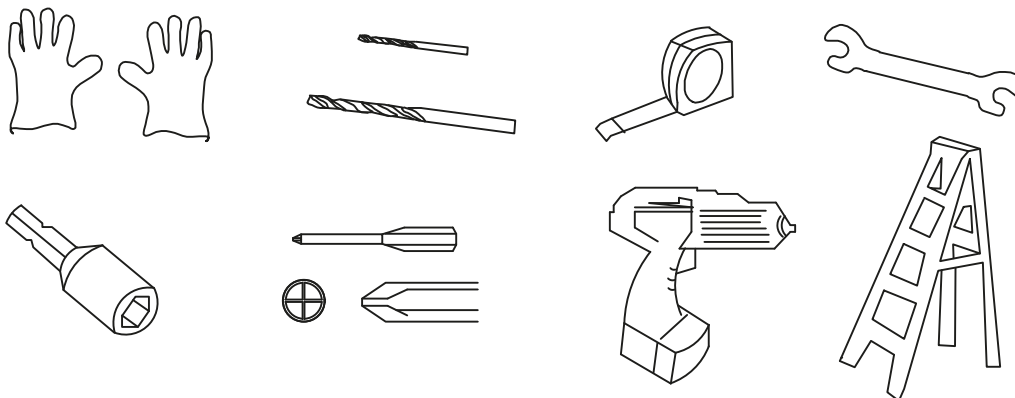

Use guantes resistentes cuando manipule láminas de acero y tapajuntas.

PLANIFIQUE CON TIEMPO

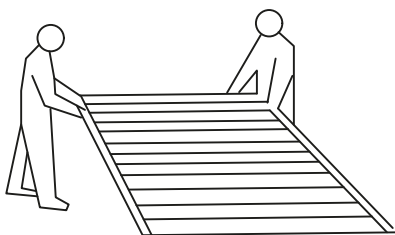

Mira el clima:

- Asegúrese de que el día que seleccione para la instalación sea seco y tranquilo.
- NO intente armar su cobertizo en clima ventoso debido al riesgo de daño a los paneles o lesiones personales. Tenga cuidado si el suelo está húmedo o resbaloso.

Trabajo en equipo:

- Siempre que sea posible, dos o más personas deben trabajar juntas para montar el galpón. Una persona puede colocar piezas o paneles mientras que el otro puede colocar tornillos y manejar las herramientas.

PLANIFICA CON TIEMPO

Selección del lugar:

- Los árboles pequeños, los arbustos o las cercas cercanas pueden ser útiles, ya que actúan como protección contra el viento.





























Preparación del lugar

































- El sitio debe estar preparado para que la base del cobertizo esté nivelada en todo su perímetro.
- Se requiere un nivel de burbuja.
- La base puede construirse con madera tratada o sobre hormigón, para detener o prevenir humedad.
- El cobertizo no está diseñado para ser construido directamente sobre el césped.
- Si se hace una plataforma de concreto, es importante que esta se incline hacia los bordes para evitar ingreso de agua.
- Se debe dejar tiempo para que se seque el concreto o el cemento antes de construir el cobertizo encima.
- Las bases también se pueden construir con ladrillos, bloques o montarse en una plataforma de concreto.
- Los ladrillos o bloques deben ser pasados sobre cemento y colocarse sobre cimientos de hormigón firmes y nivelados y el marco del galpón debe ser perforado y atornillado a la base.

































NOTAS IMPORTANTES

- Encuentre a alguien que lo ayude: es mucho más fácil si alguien lo ayuda a sostener las piezas, pasarle herramientas , etc .
- También algunos pasos requieren que dos personas levanten estructuras juntas. Esto no significa trabajo pesado, por lo que se adaptaría a la mayoría de las personas sin discapacidad.
- Permita suficiente tiempo para el montaje: apresurarse causa errores.
- Si nunca ha construido un cobertizo antes, puede tomar la mayor parte de un día para completar su armado.
- Tenga las herramientas adecuadas a mano.
- Utilice Ropa de seguridad como se recomienda en la sección 'Herramientas'.
- Lo ideal es revisar las piezas y comprobar que todas estén presentes antes de comenzar la construcción.
- Colocar sobre telas o láminas de plástico si existe riesgo de rayar las piezas.
- Apriete todas las tuercas con cuidado, asegurándose de no perder ninguna. Verifique que el marco esté en escuadra utilizando un nivel de burbuja para comprobar que está en posición vertical.

LISTA DE PARTES

PART	NO.	Qty.
	1	2
	2	2
	3	2
	3L	1
	3R	1
	4L	1
	4R	1
	5L	1
	5R	1
	6L	1
	6R	1
	7	1
	8	2
	9	2
	10L	1
	10R	1
	11	2
	12L	1
	12R	2
	12	4
	13	4
	14	4
	15	6
	16	2
	17	2
	7L	1
	7R	1
	18	2
	19	7

PART	NO.	Qty.
	21L	2
	21R	2
	22	2
	23	1
	24	2
	25L	1
	25R	1
	35	1
	31	4
	32	4
	33	4
	34	2
	B1	2
	B2	2
	B3	4
	J4	2
	L1	16
	P1	9
	P2	2
	P3	2
	P4	1
	P5	1
	P6	1
	P7	1
	P6L	1
	P6R	1
	P4L	8
	P4R	6
	F5	100
	GC	4
	GE	2
	GF	4

PART	NO.	Qty.
	D1	2
	D2	1
	30	4
	29	4
	29-1	4
	36	1
	37	1
	38	1
	39	1
	40	1
	41	1
	42	2
	43	4
	44	1
	45	1
	46	1
	47	1
	48	2
	49	2
	50	2
	J1	4
	J2	4
	J3	2
	B5	3
	B6	9
	H1	2
	H2	2
	J5	1
	J6	1
	F1	900
	F2	200
	F3	40
	F4	17

MEDIDAS

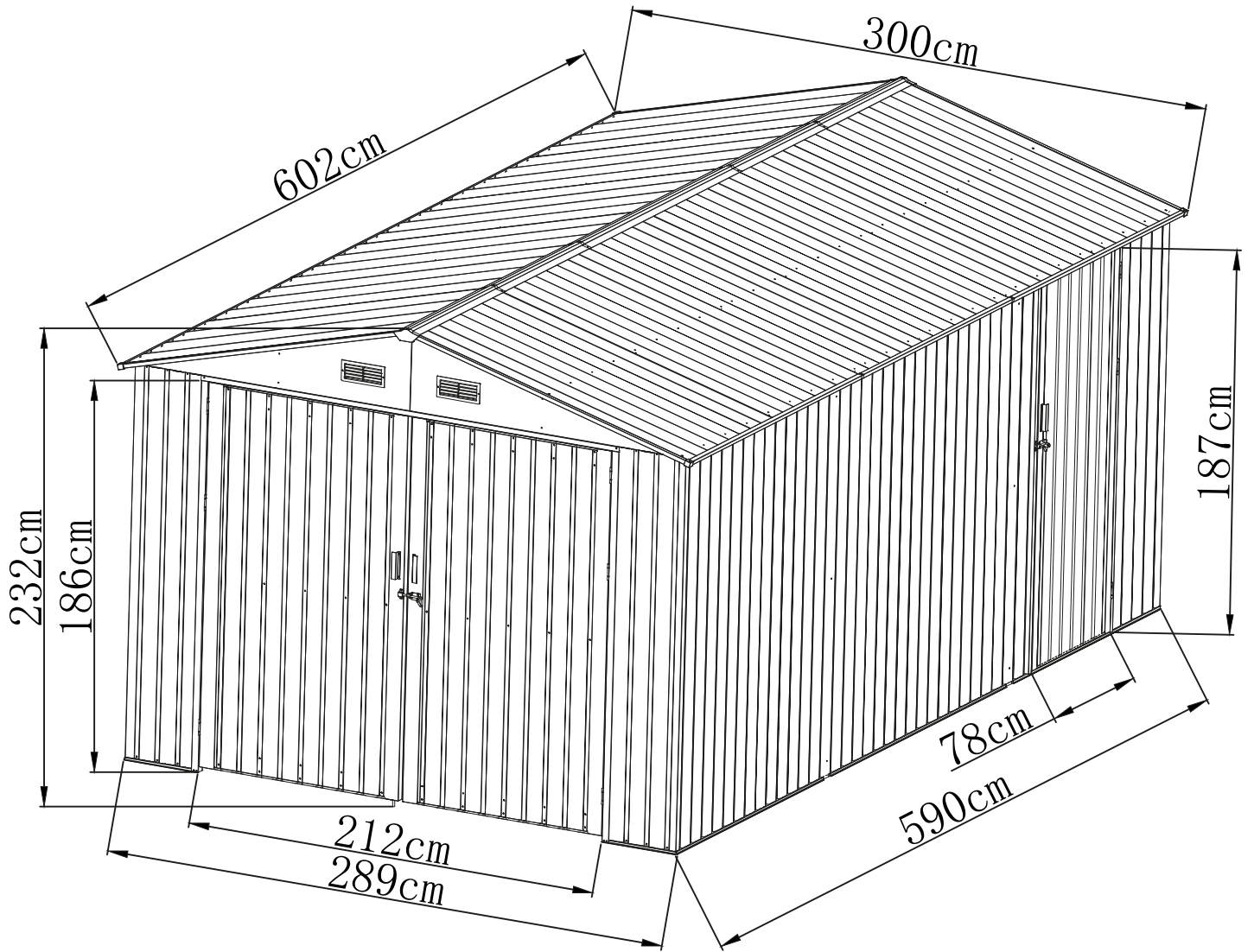

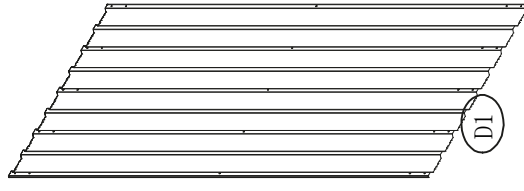
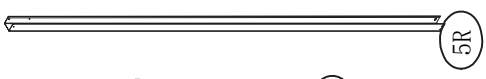
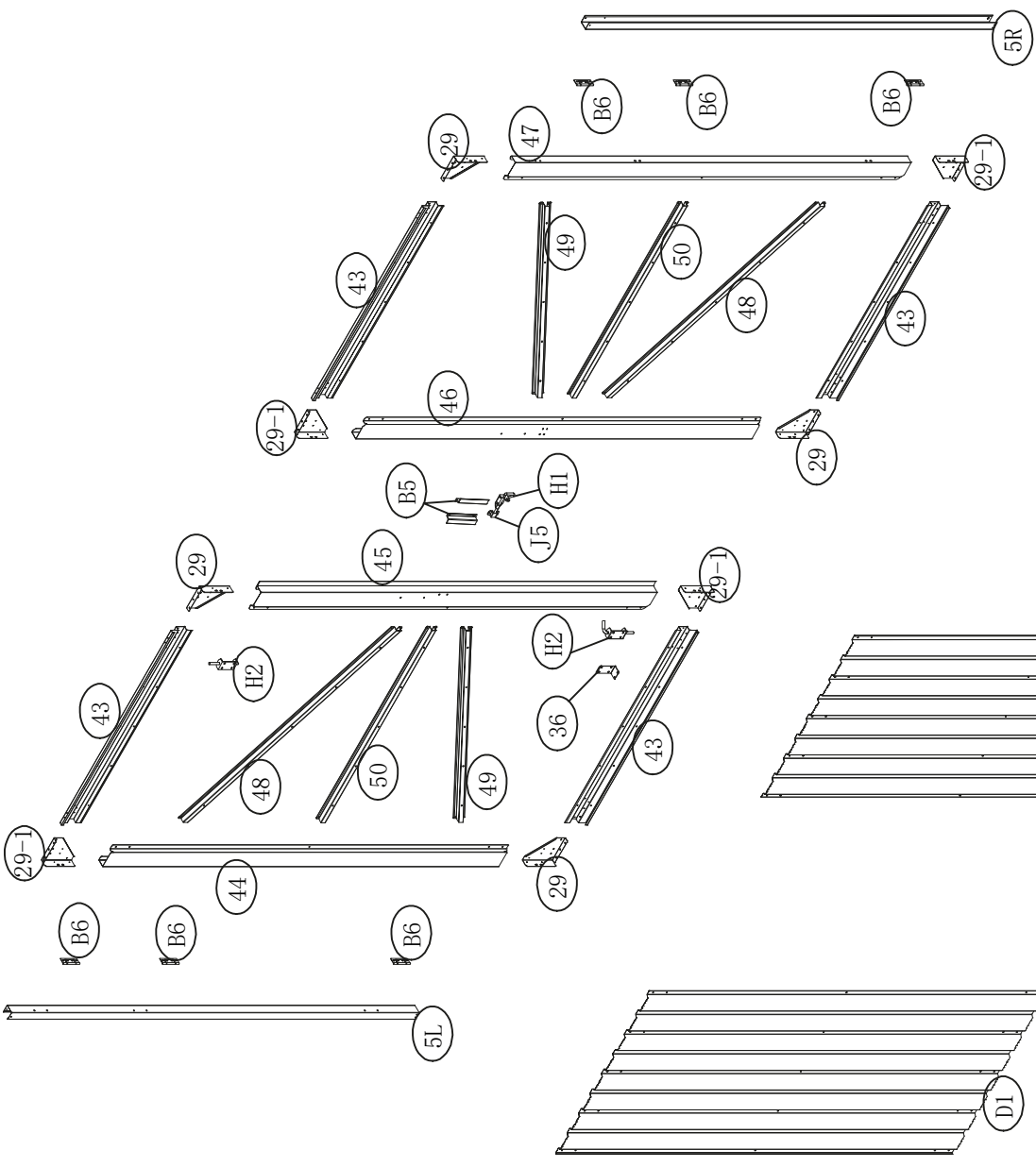
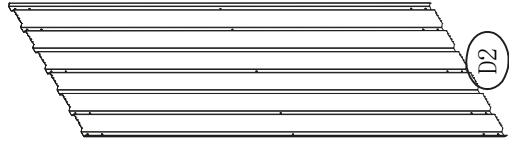
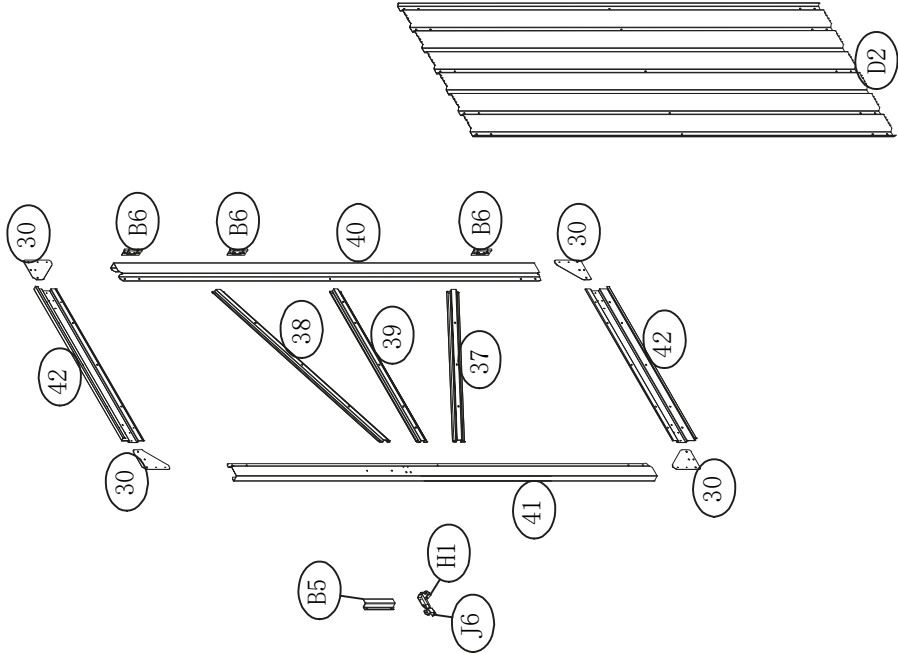

MONTAJE DEL MARCO DE LA BASE

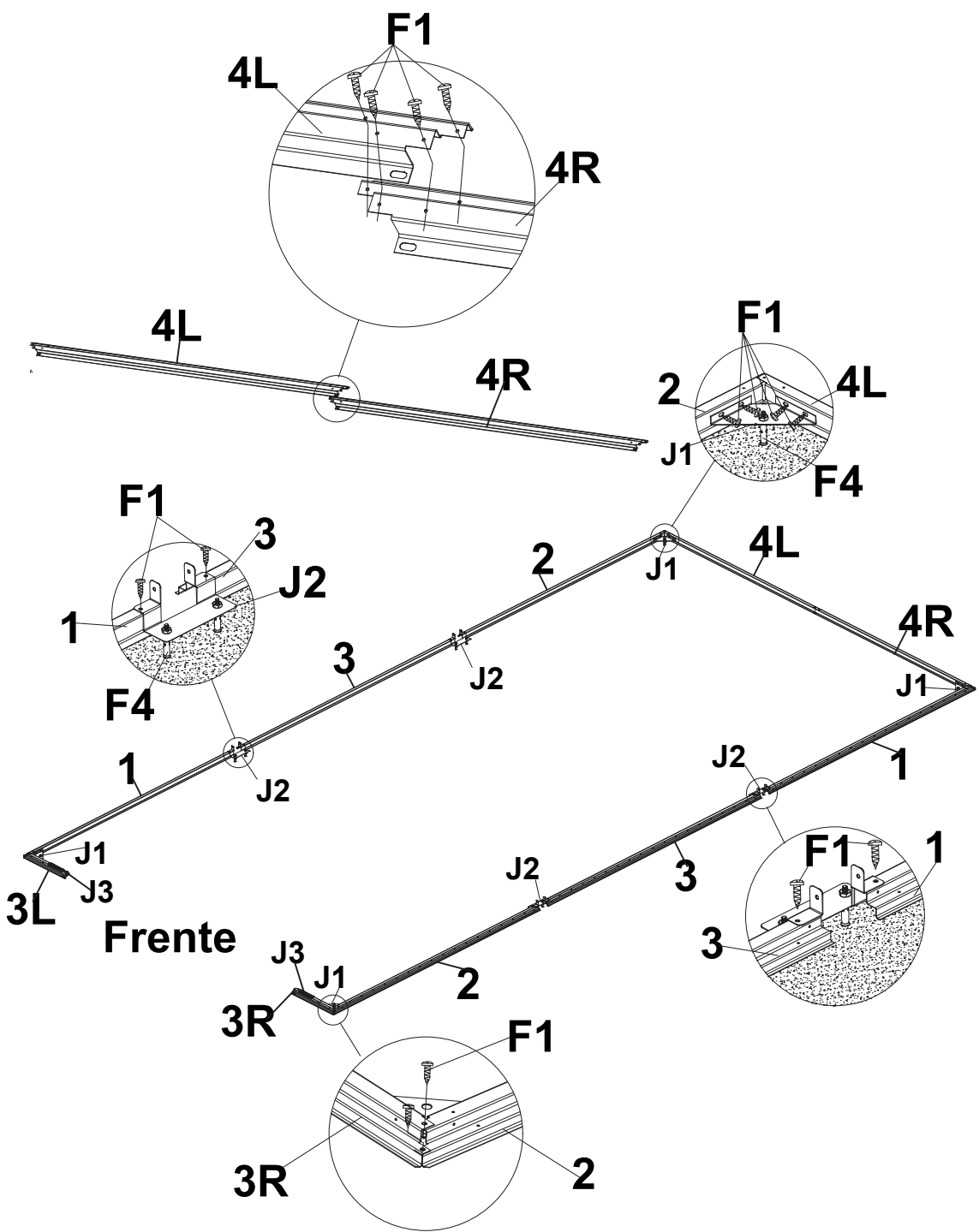

PARTE	NO.	Cant.
	1	2
	2	2
	3L	1
	3R	1
	4L	1
	4R	1
	3	2
	J1	4
	J2	4
	J3	2
	F1	
	F4	

- Tenga cuidado con los bordes afilados, asegúrese de usar guantes.
- Busque las partes enumeradas, organice bien la posición de las piezas como se muestra en la imagen y asegure las partes con tornillos (F1).
- Asegúrese de que la base esté bien escuadrada.
- Hay agujeros adicionales en los marcos que se pueden utilizar para asegurar el cobertizo a una base de madera o una plataforma de concreto.

MONTAJE DE LA PARED LATERAL

Nota: Mantenga un espacio de 7-8 cm entre cada barra mejorada, izquierda y derecha de los lados según el diagrama.

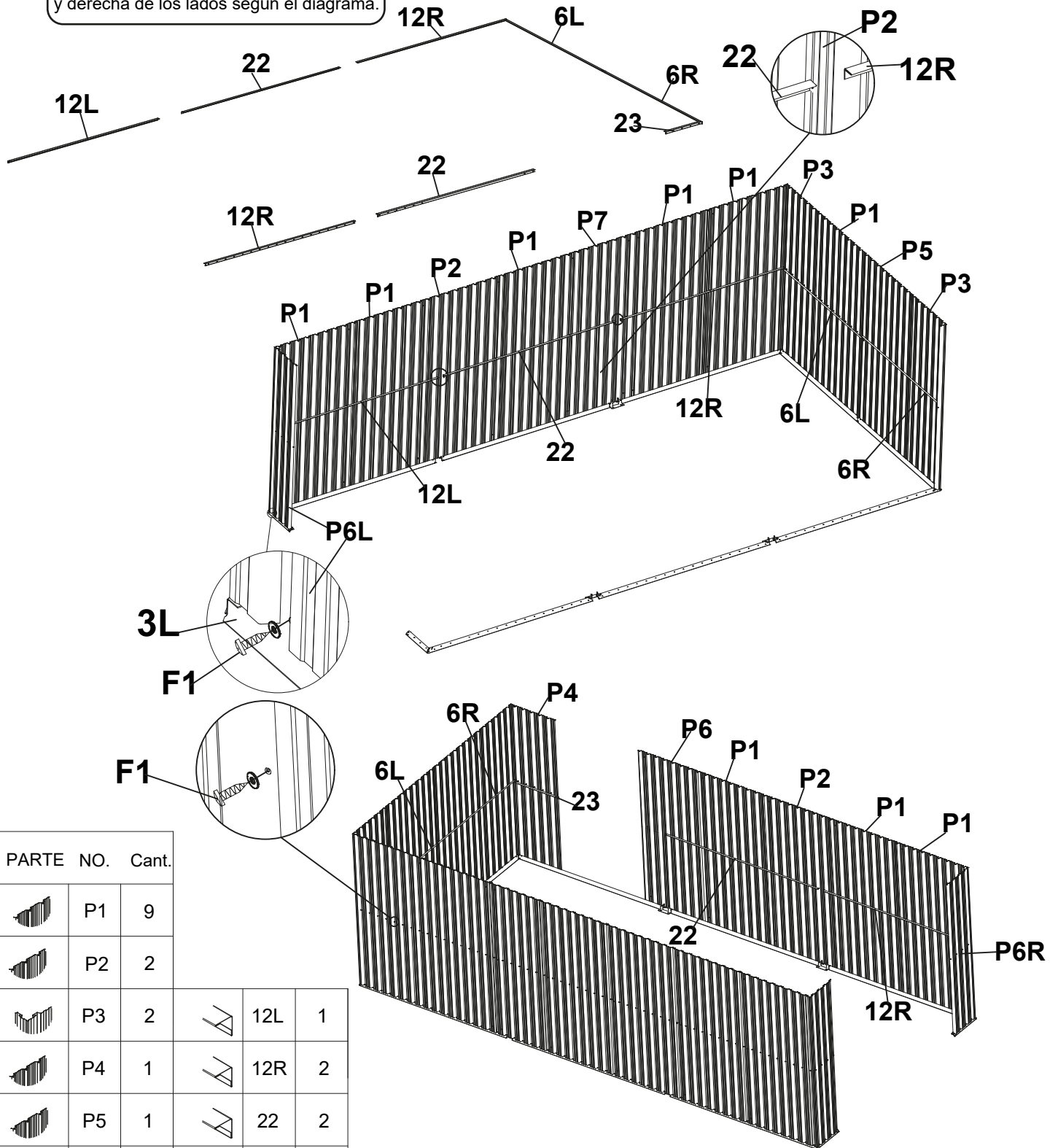





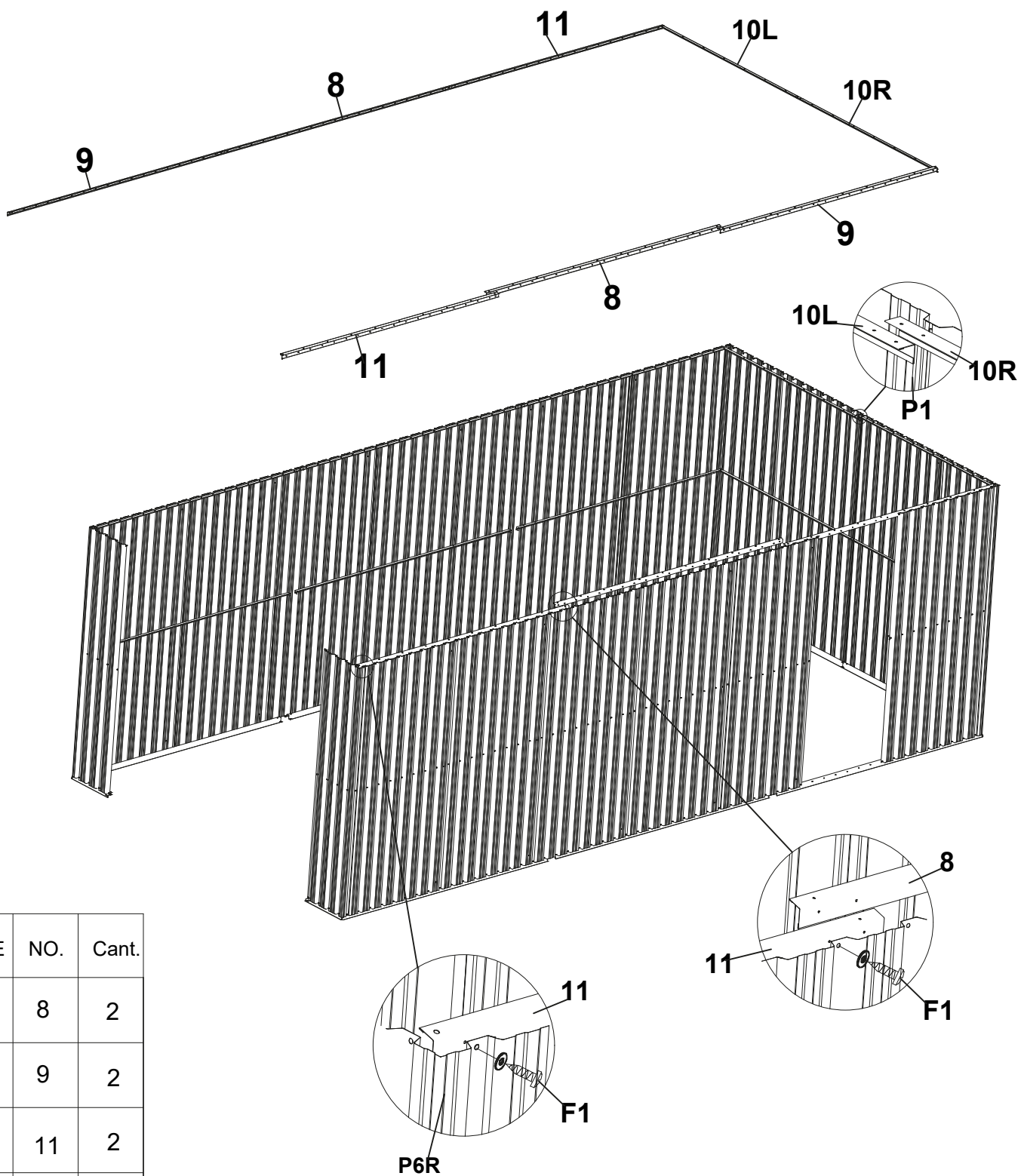

PARTE	NO.	Cant.		
	P1	9		
	P2	2		
	P3	2		12L 1
	P4	1		12R 2
	P5	1		22 2
	P6	1		23 1
	P7	1		6L 1
	P6L	1		6R 1
	P6R	1		F1

Advertencia:
NO COMPLETE ESTE PASO EN DÍAS VENTOSOS.

Estudie con atención las piezas enumeradas. Coloque los paneles en la base uno por uno, fije las barras en el medio de la pared conjuntamente para evitar el derrumbe del muro.

MONTAJE DEL MARCO SUPERIOR



PARTE	NO.	Cant.
	8	2
	9	2
	11	2
	10L	1
	10R	1
	F1	

Coloque con cuidado cada barra superior como se muestra en la imagen y fijela con tornillos y arandelas (F1).

MONTAJE DEL MARCO DE SOPORTE 1

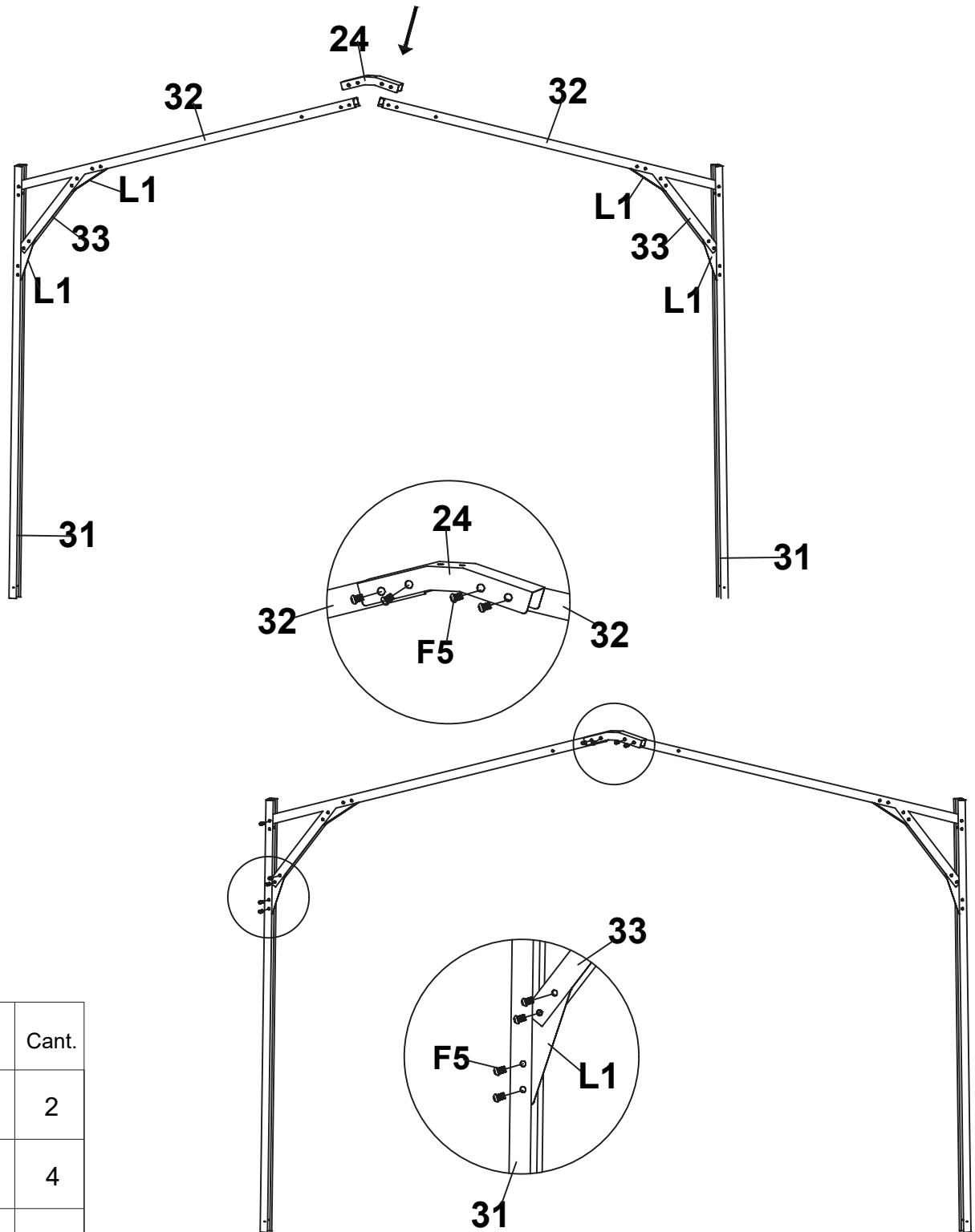

PARTE	NO.	Cant.
	24	2
	31	4
	32	4
	33	4
	L1	16
	F5	

Estudie todas las partes enumeradas, vinculelas una por una como se muestra en la imagen y sujete con F5.
 Recuerde que se necesitan 2 juegos de marcos de soporte para ser montado.

MONTAJE DEL MARCO DE SOPORTE 2

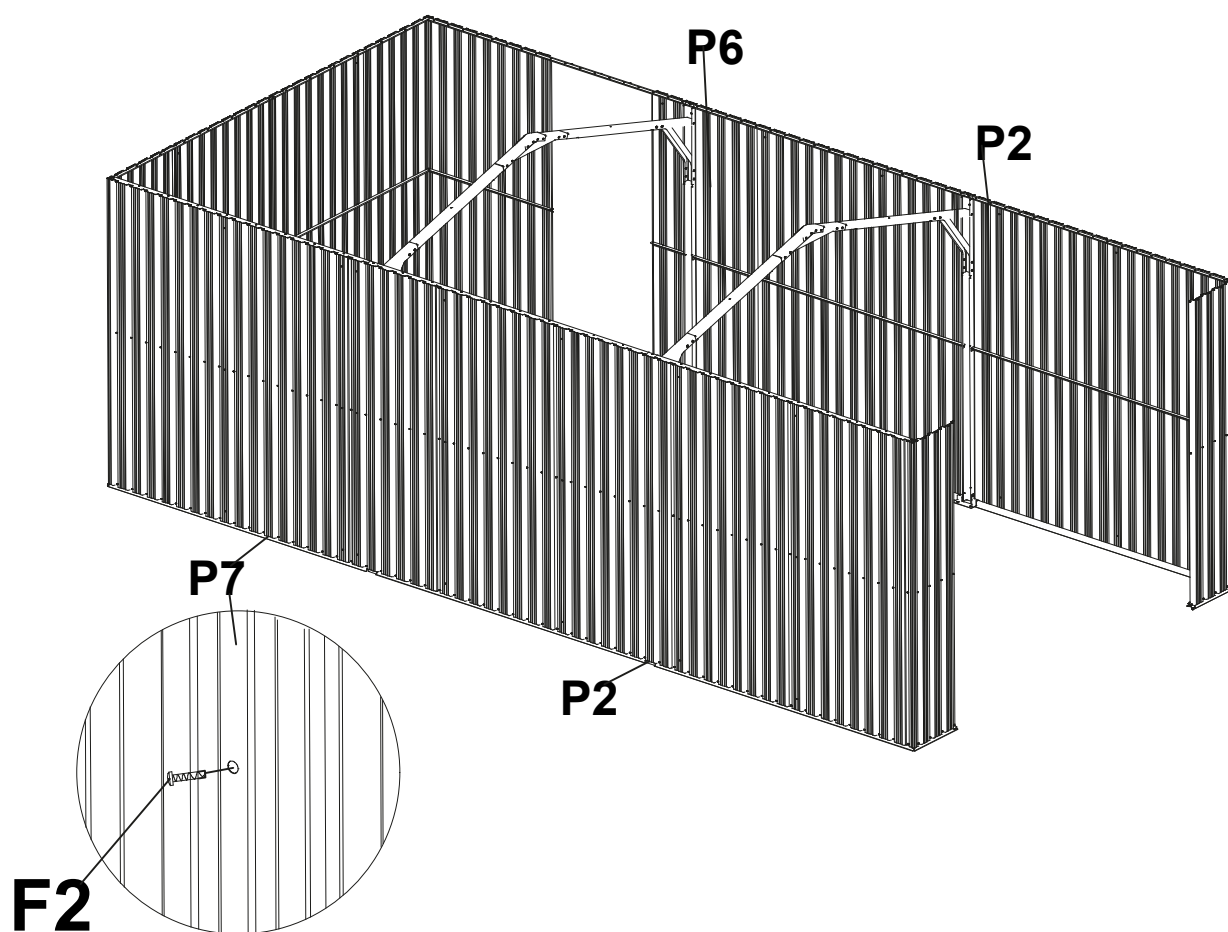

PARTE	NO.	Cant.
	F2	

Coloque el marco del soporte correctamente (vea el espacio de 7-8 cm mencionado en la instalación de la pared), fíjelos a los paneles con un tornillo (F2).

MONTAJE DE LOS MARCOS DE LA PUERTA

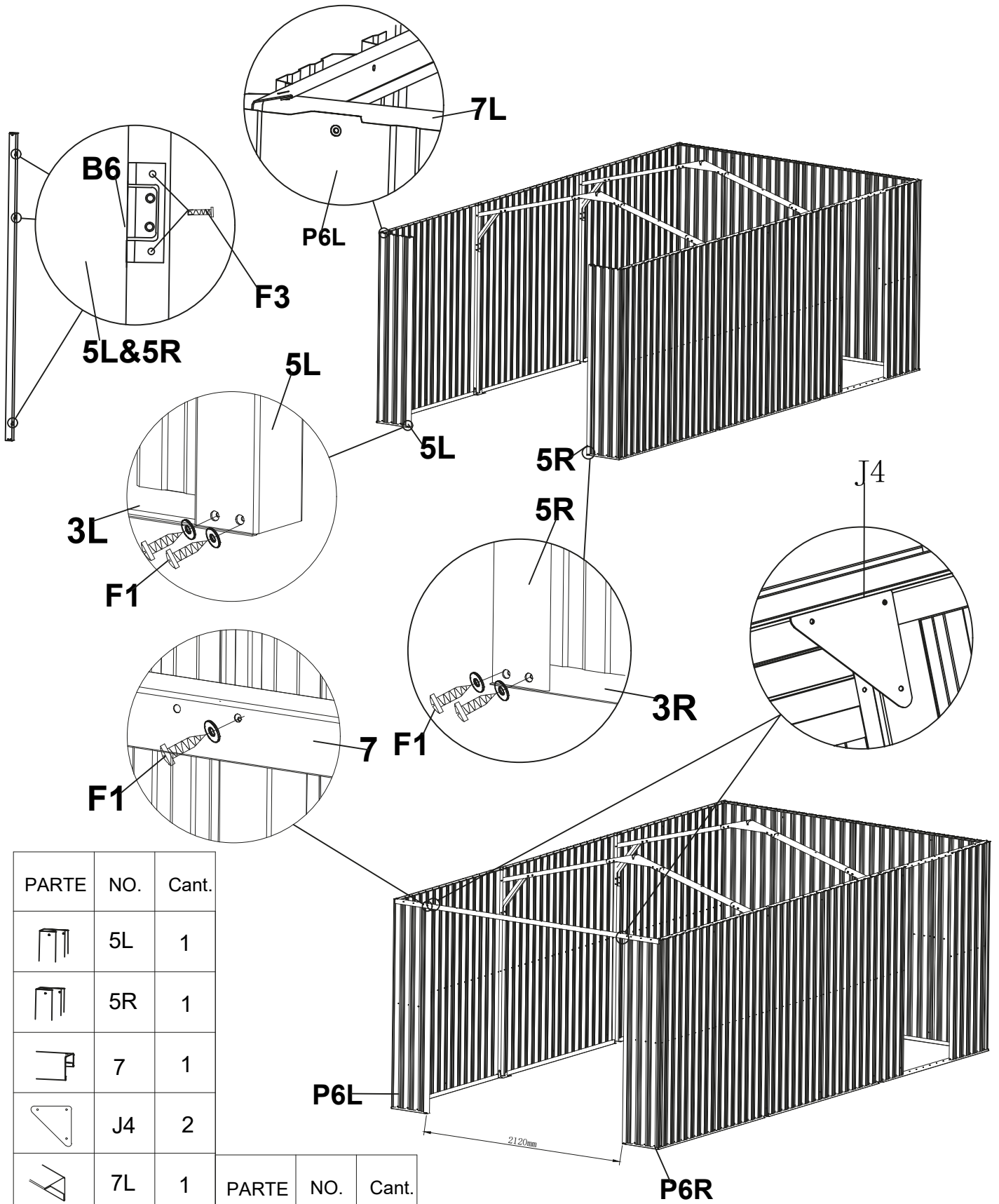

PARTE	NO.	Cant.
	5L	1
	5R	1
	7	1
	J4	2

PARTE	NO.	Cant.
	7L	1
	7R	1
	B6	6
	F1	
	F3	

MONTAJE DEL AGUILÓN



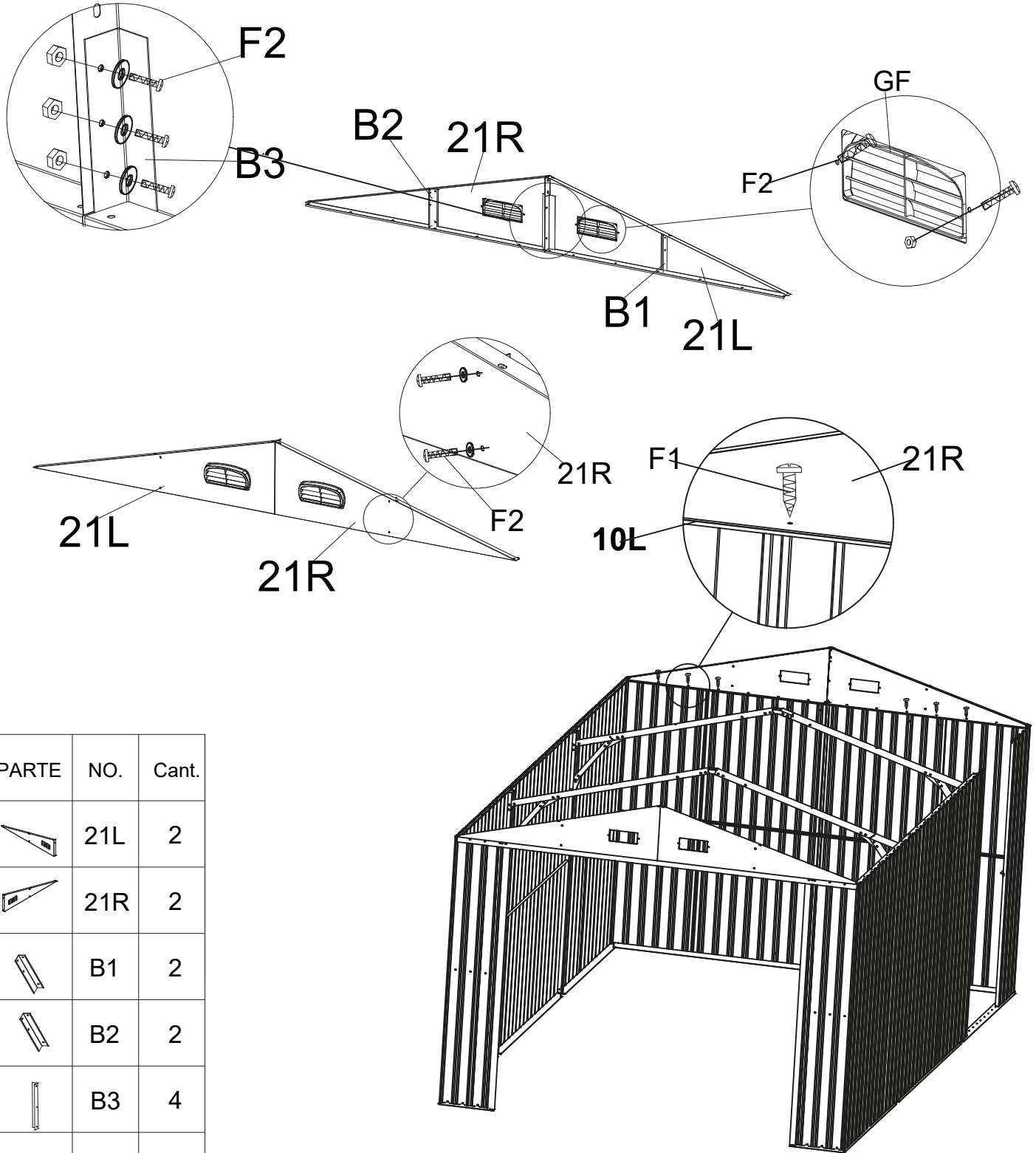

Nota: Atornille cada agujero.

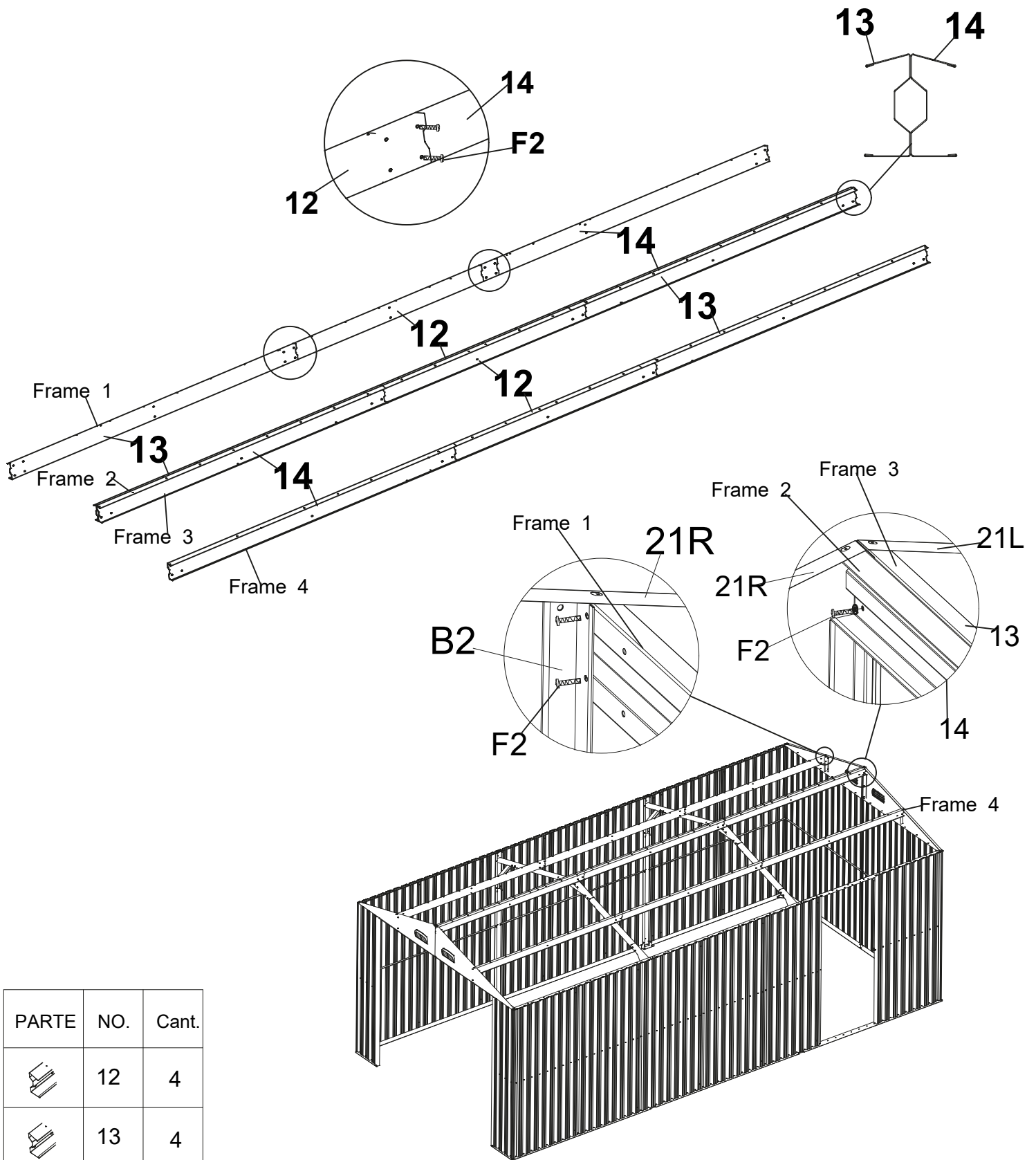

PARTE	NO.	Cant.
	21L	2
	21R	2
	B1	2
	B2	2
	B3	4
	GF	4
	F1	
	F2	

MONTAJE DEL MARCO DEL TECHO



PARTE	NO.	Cant.
	12	4
	13	4
	14	4
	F2	

REFUERZO VIGA SUPERIOR 1

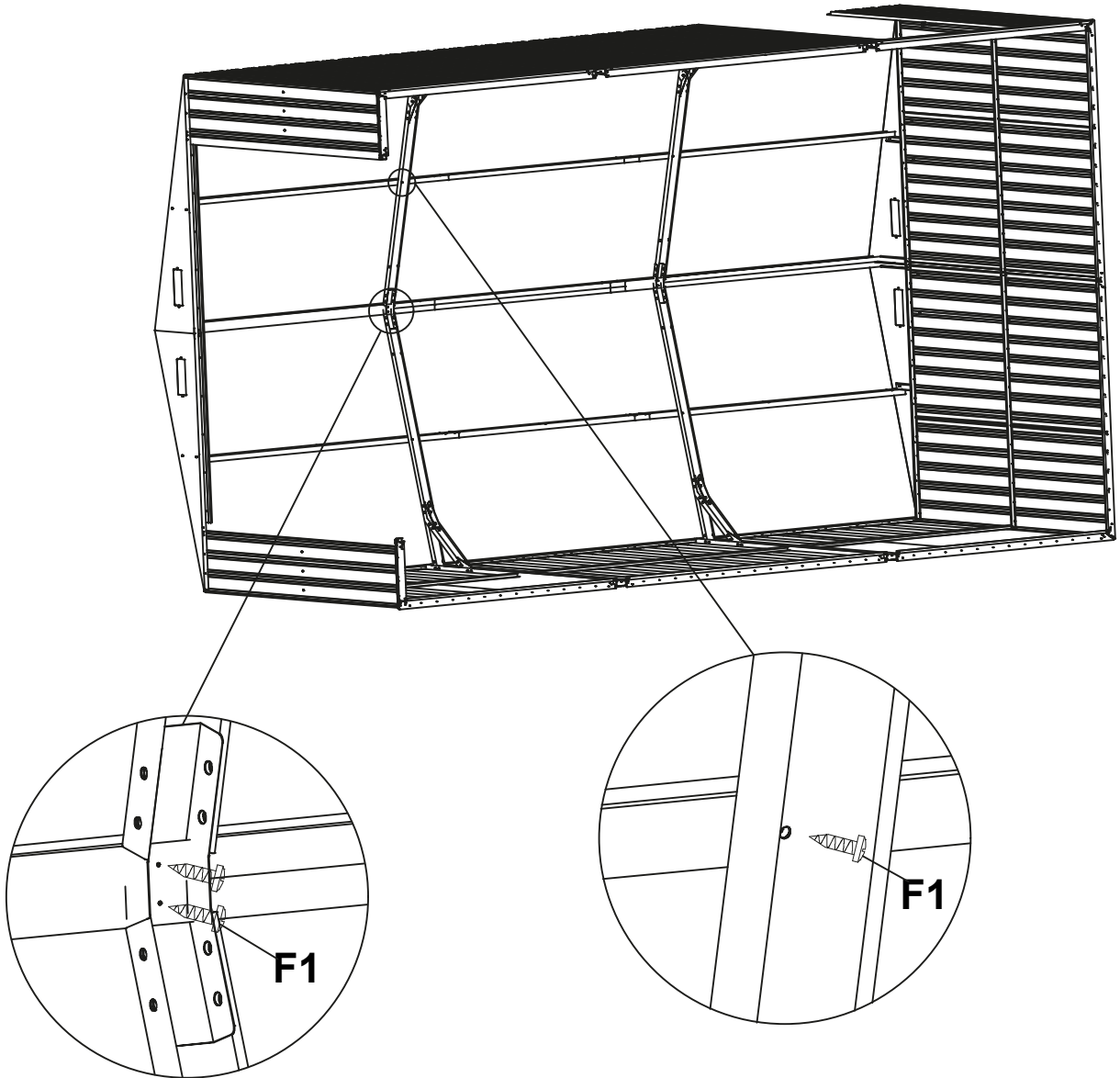

↑
ARRIBA

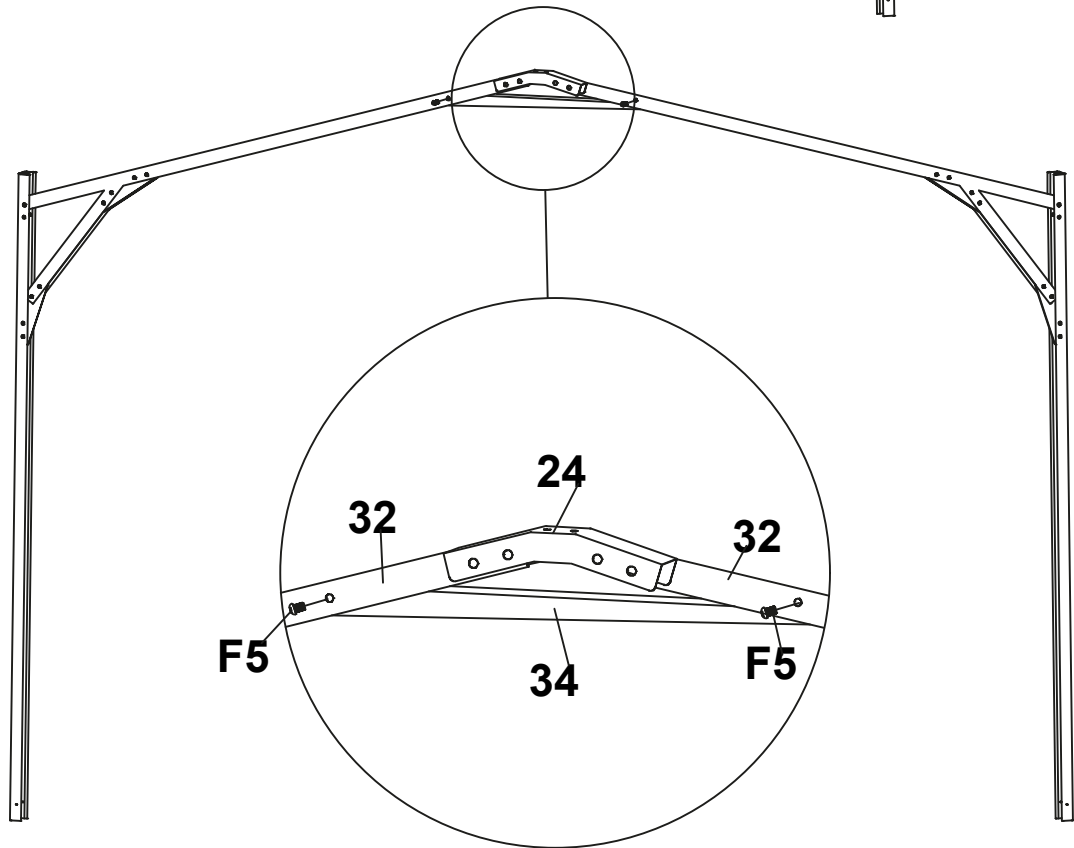
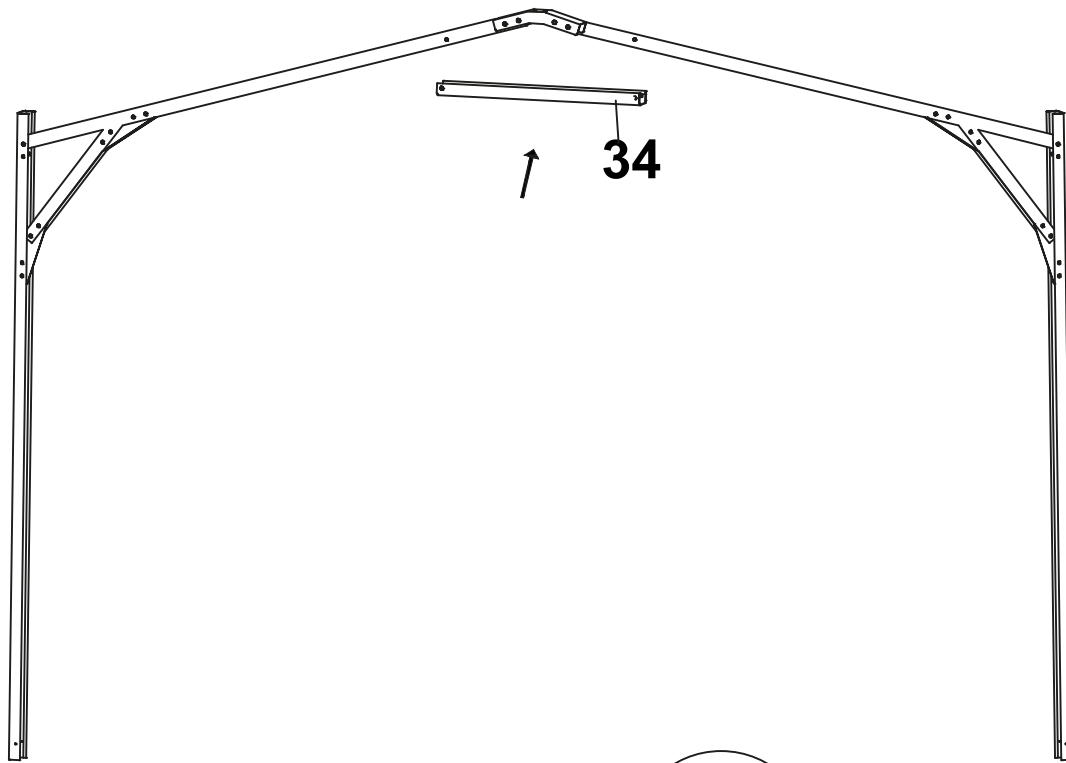

PARTE	NO.	Cant.
	F1	

REFUERZO VIGA SUPERIOR 2





PARTE	NO.	Cant.
	34	2
	F5	

MONTAJE DEL PANEL DEL TECHO

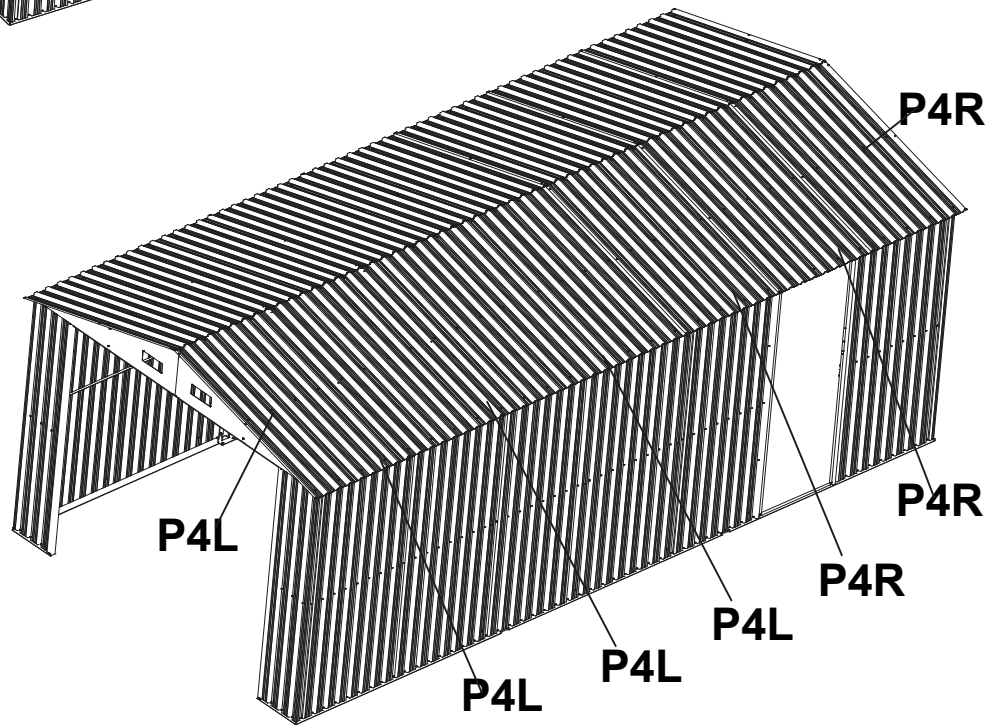
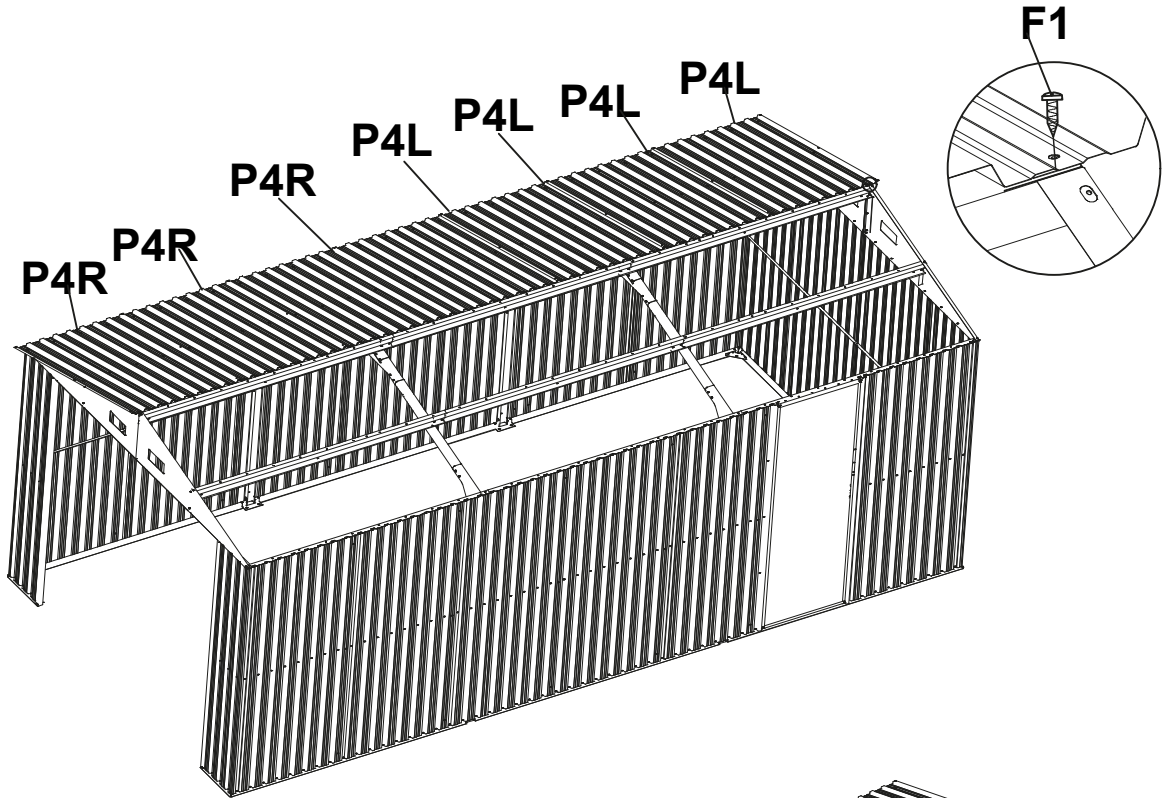
Nota: Atornille cada orificio en los paneles.







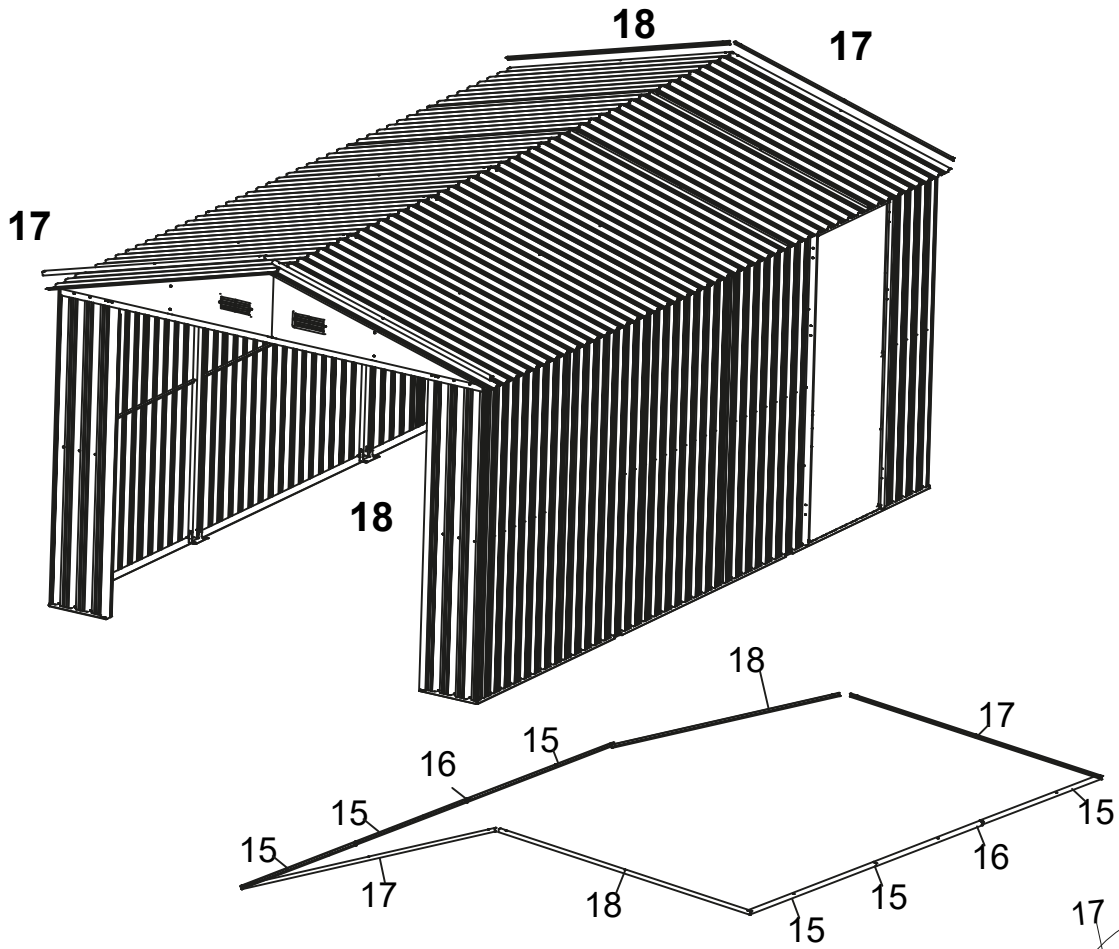

PARTE	NO.	Cant.
	P4L	8
	P4R	6
	F1	

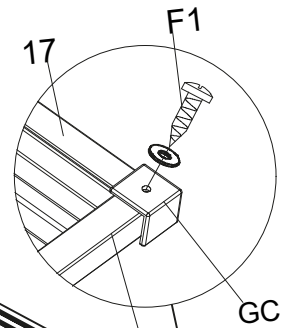
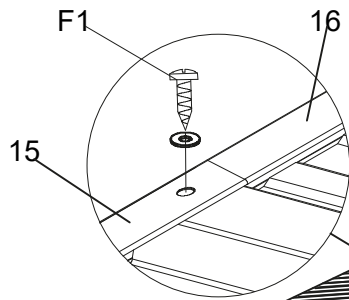
MONTAJE DE TAPAJUNTAS



Nota: Atornille cada agujero en el borde de la barra de techo



PARTE	NO.	Cant.
	15	6
	16	2
	17	2
	18	2
	GC	4
	F1	

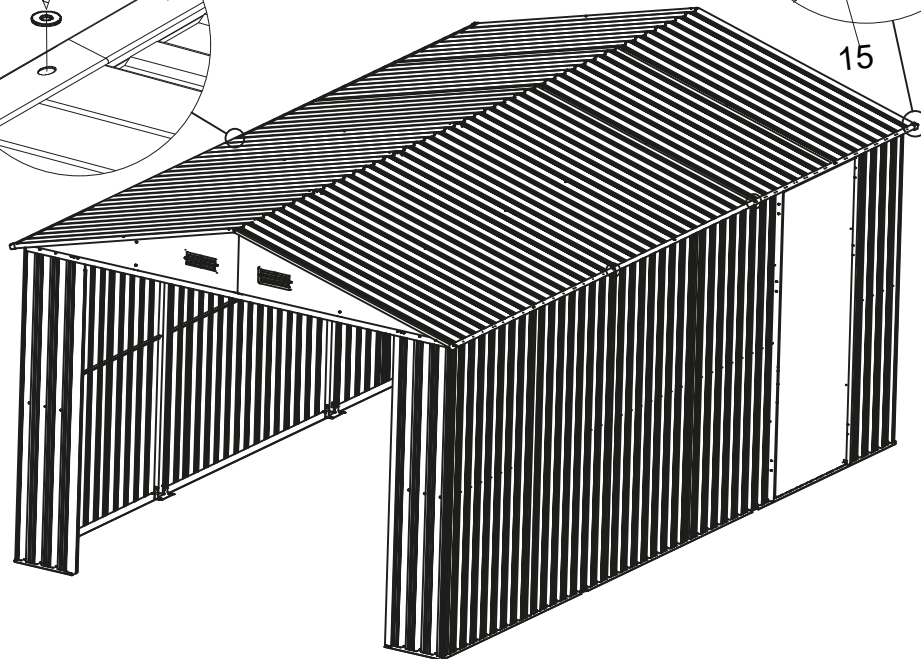

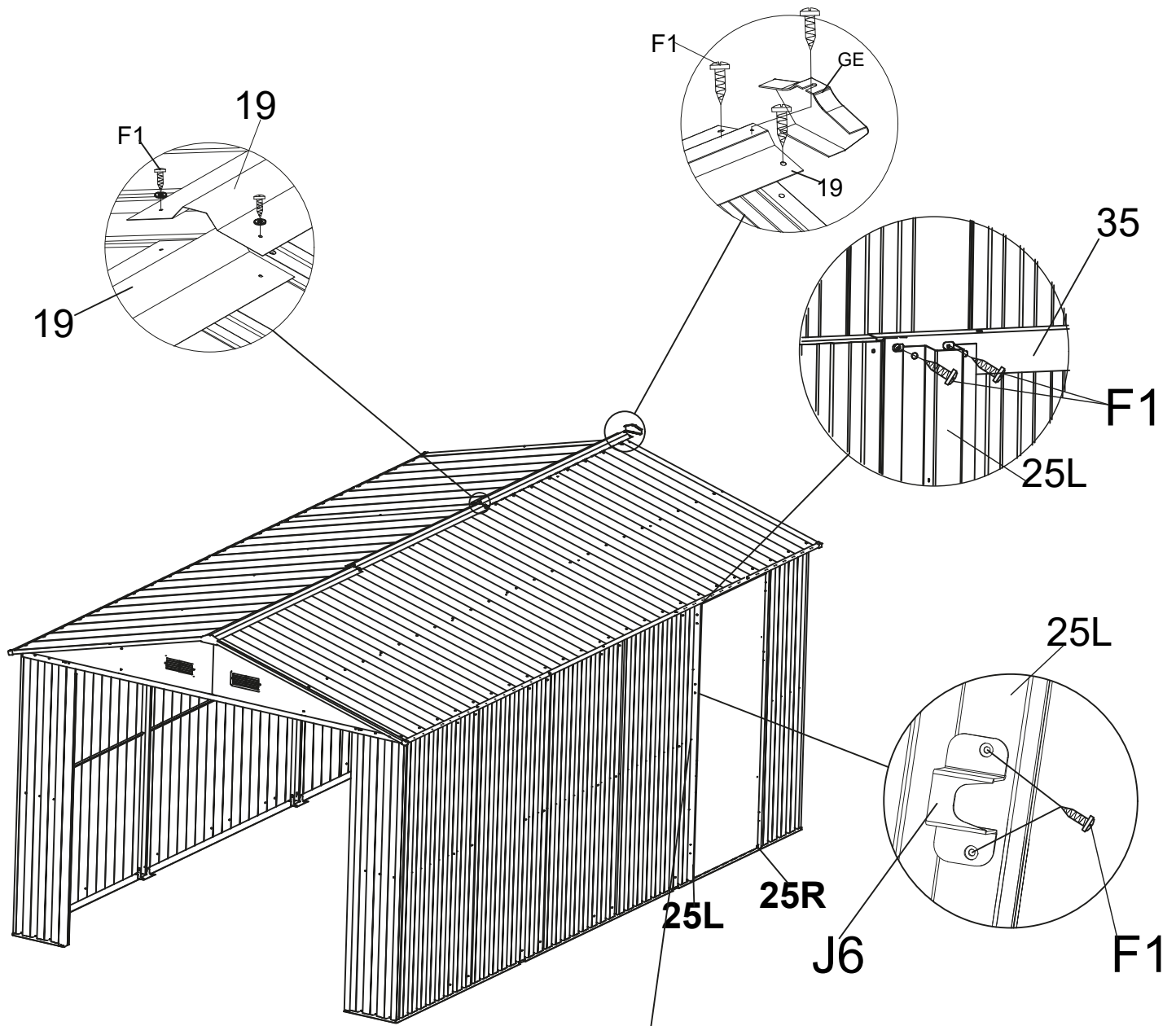





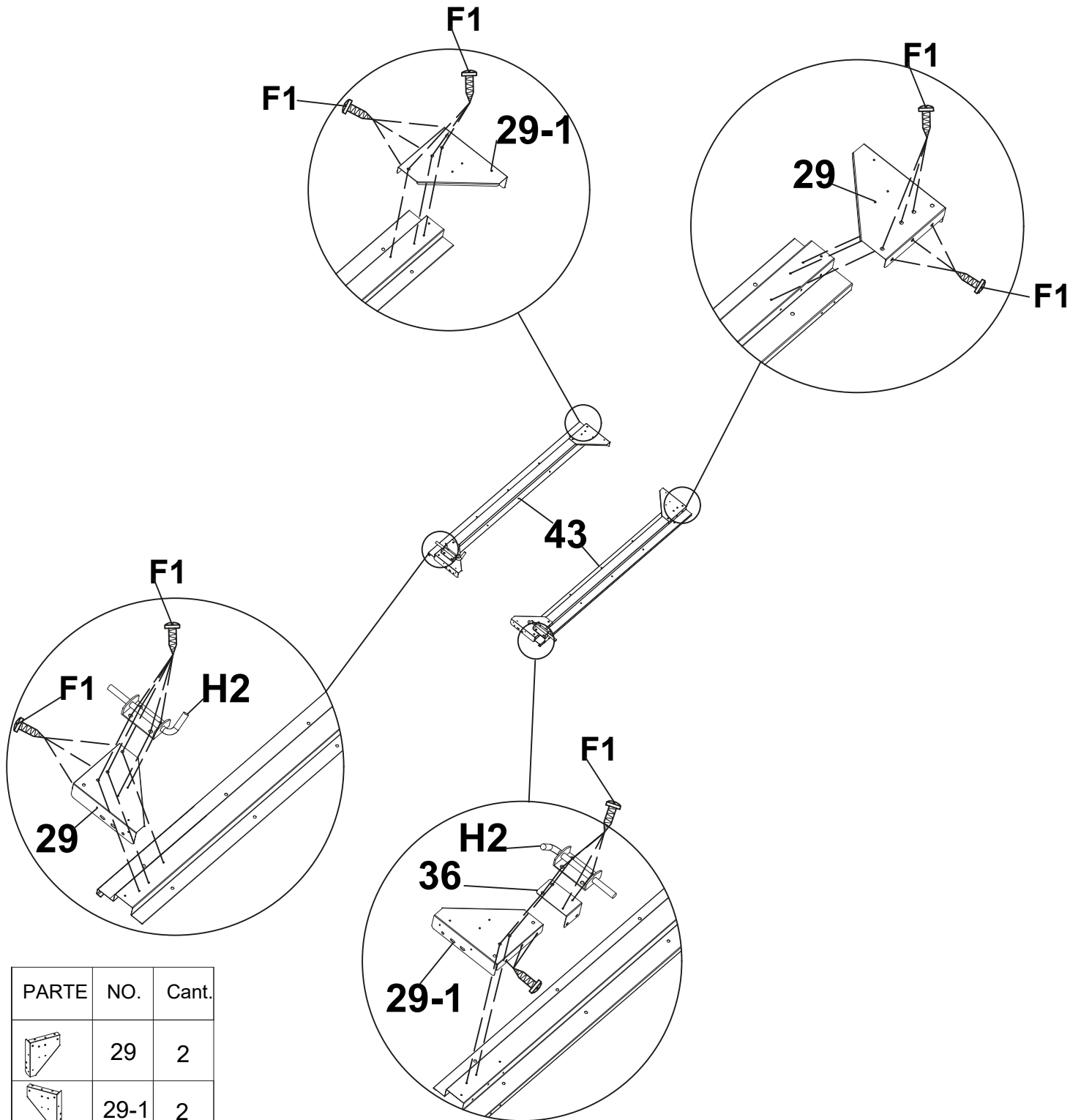

PARTE	NO.	Cant.
	19	7
	GE	2
	F1	
	25L	1
	25R	1

PARTE	NO.	Cant.
	F2	1
	J6	1
	35	1





MONTAJE DE LA PUERTA 1

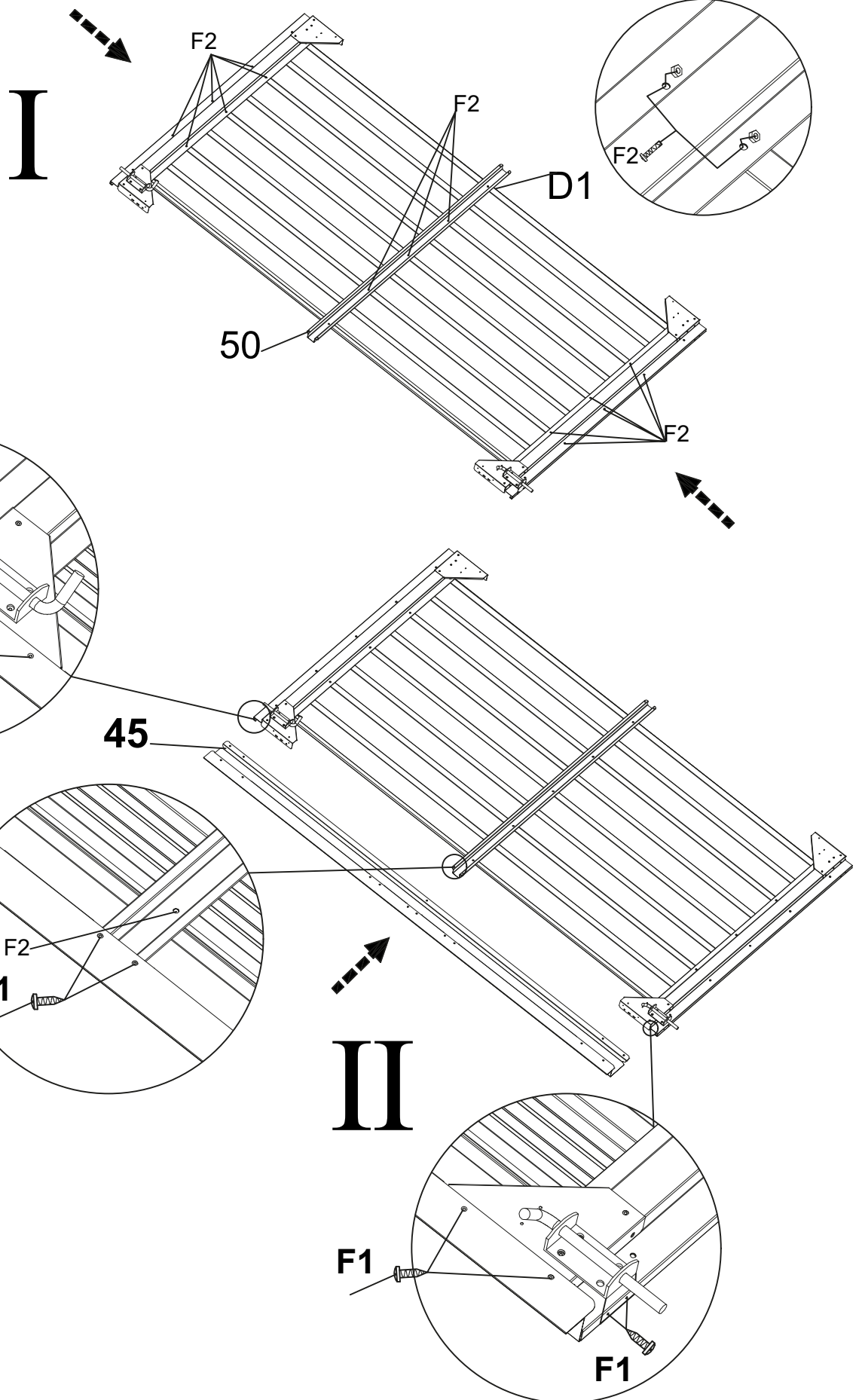

PARTE	NO.	Cant.
	29	2
	29-1	2
	43	2
	H2	2
	36	1
	F1	

MONTAJE DE LA PUERTA 2





PARTE	NO.	Cant.
	45	1
	50	1
	D1	1
	F2	
	F1	

MONTAJE DE LA PUERTA 3

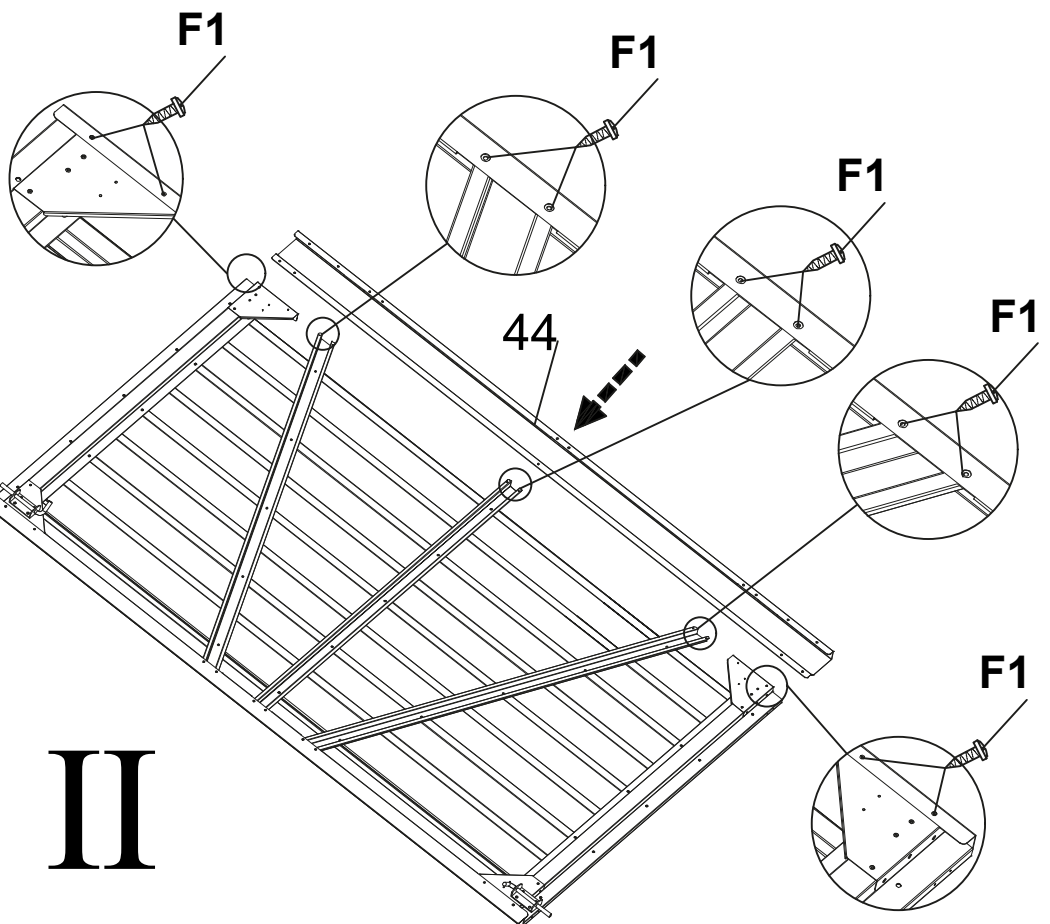
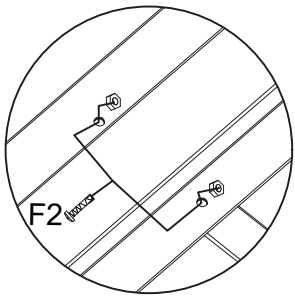
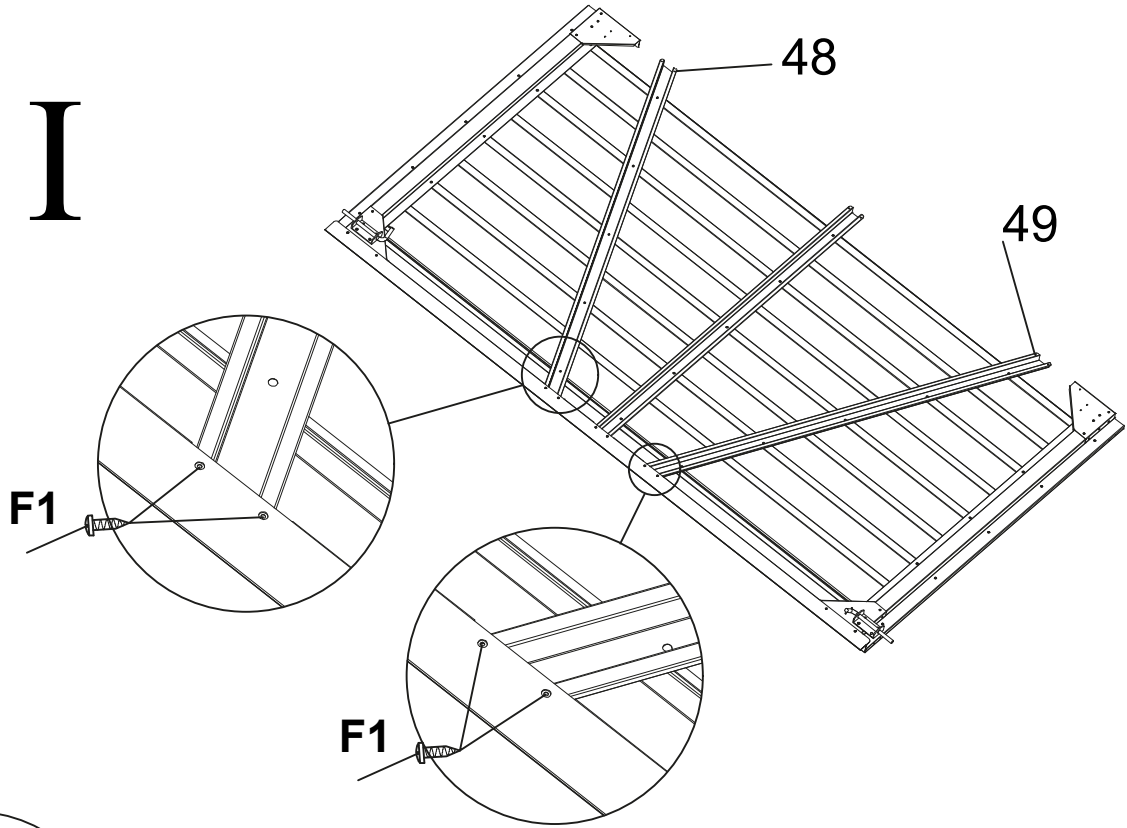
I



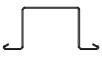
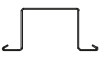
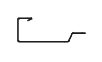

II

PARTE	NO.	Cant.
	48	1
	49	1
	44	1
	F1	

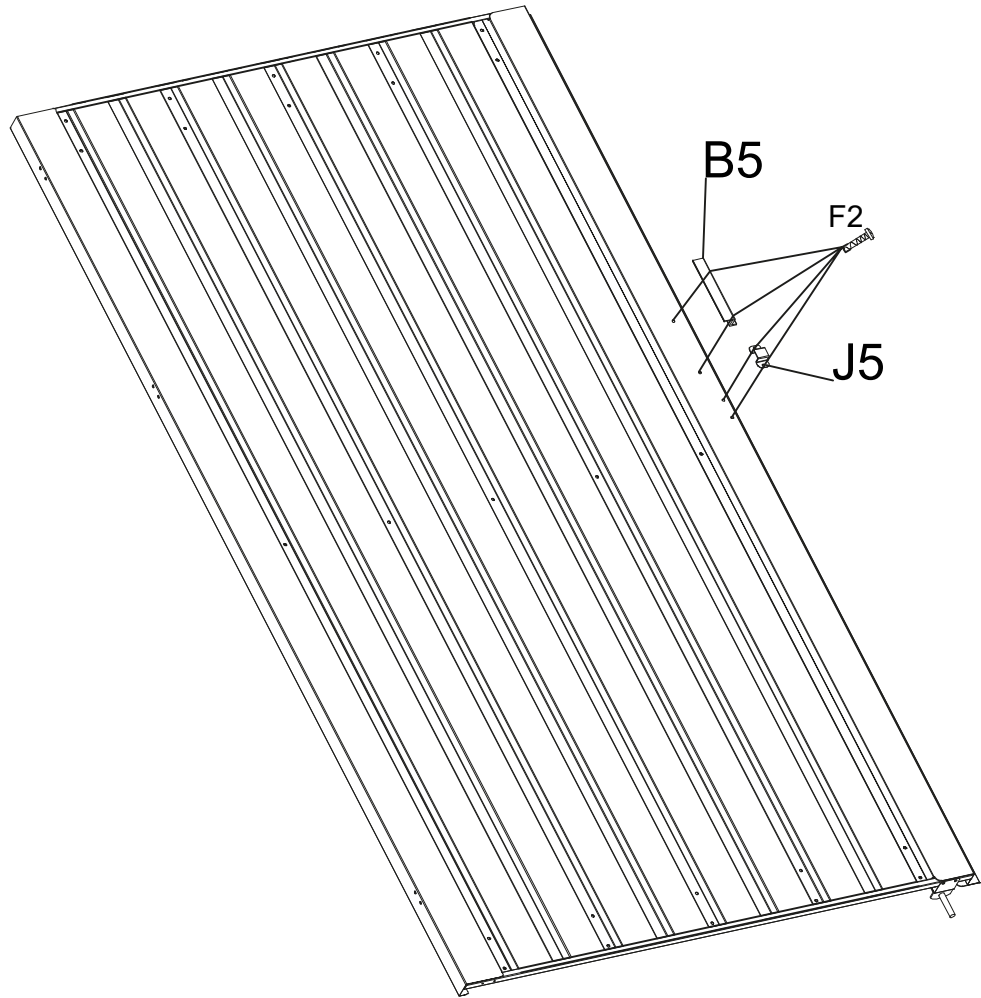
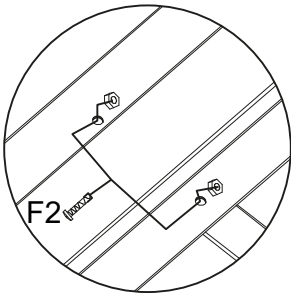

MONTAJE DE LA PUERTA 4

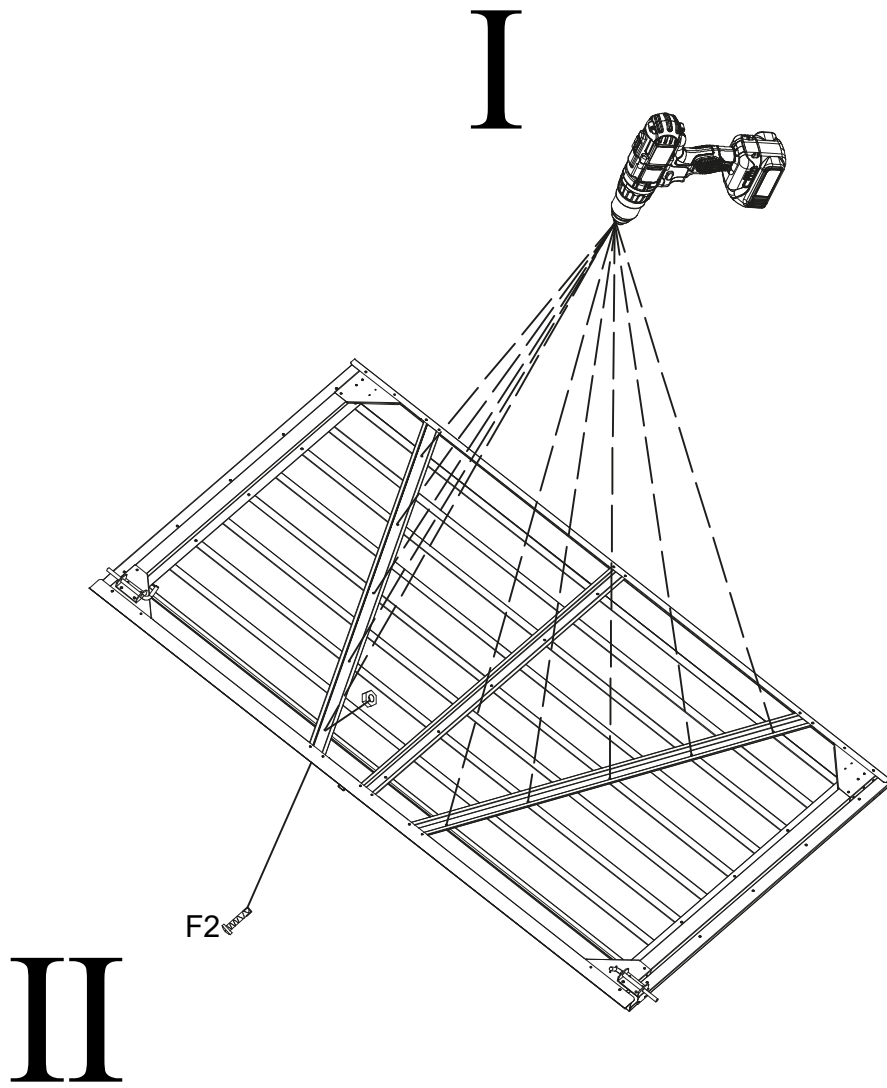

PARTE	NO.	Cant.
	B5	1
	J5	1
	F2	

MONTAJE DE LA PUERTA 5



PARTE	NO.	Cant.
	F2	
		



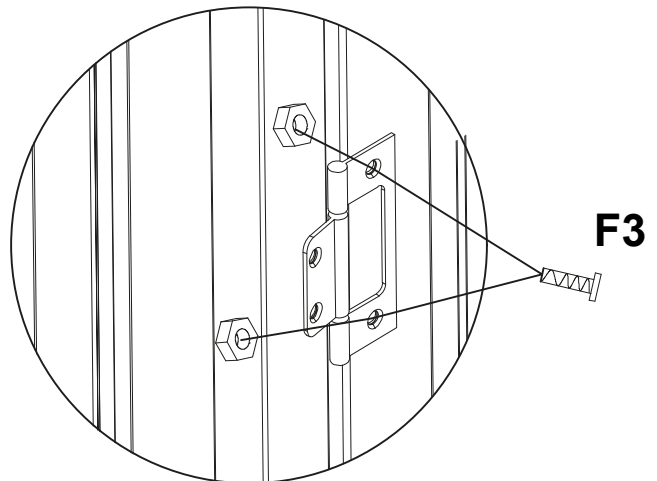
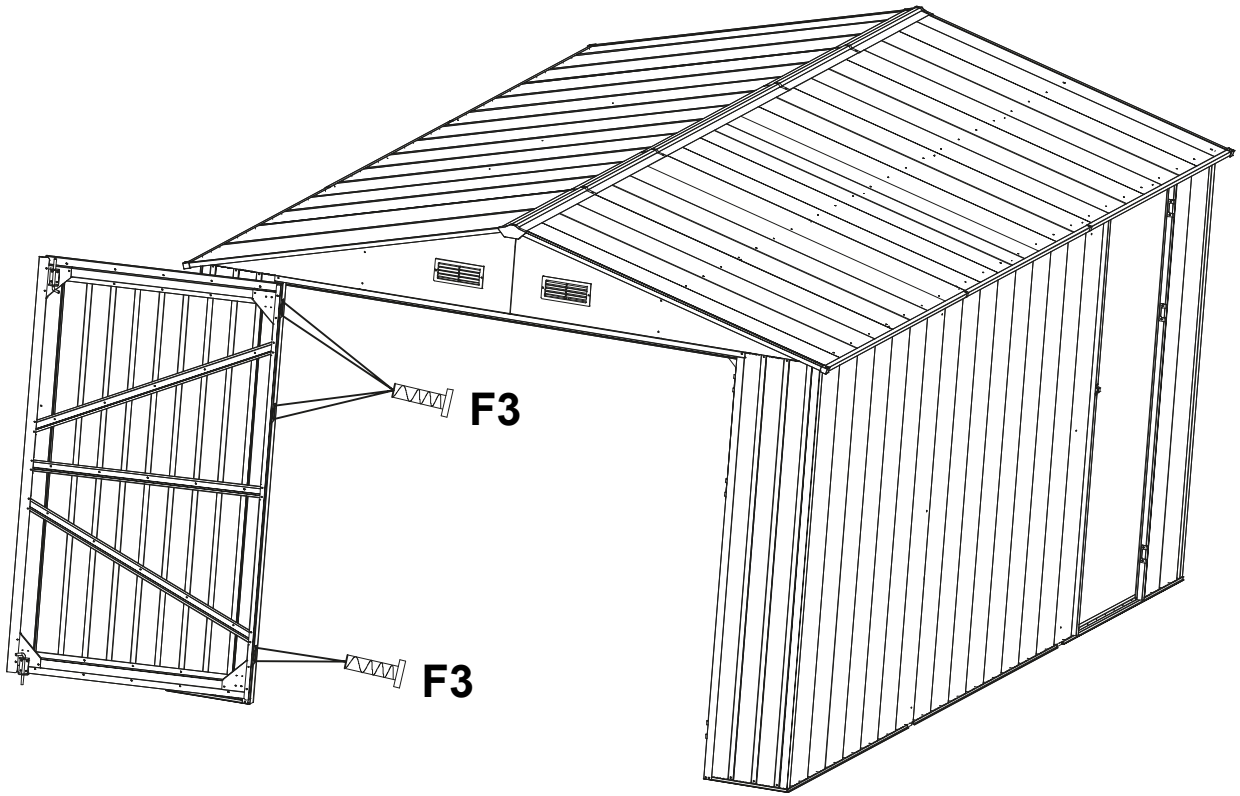

MONTAJE DE LA PUERTA 6

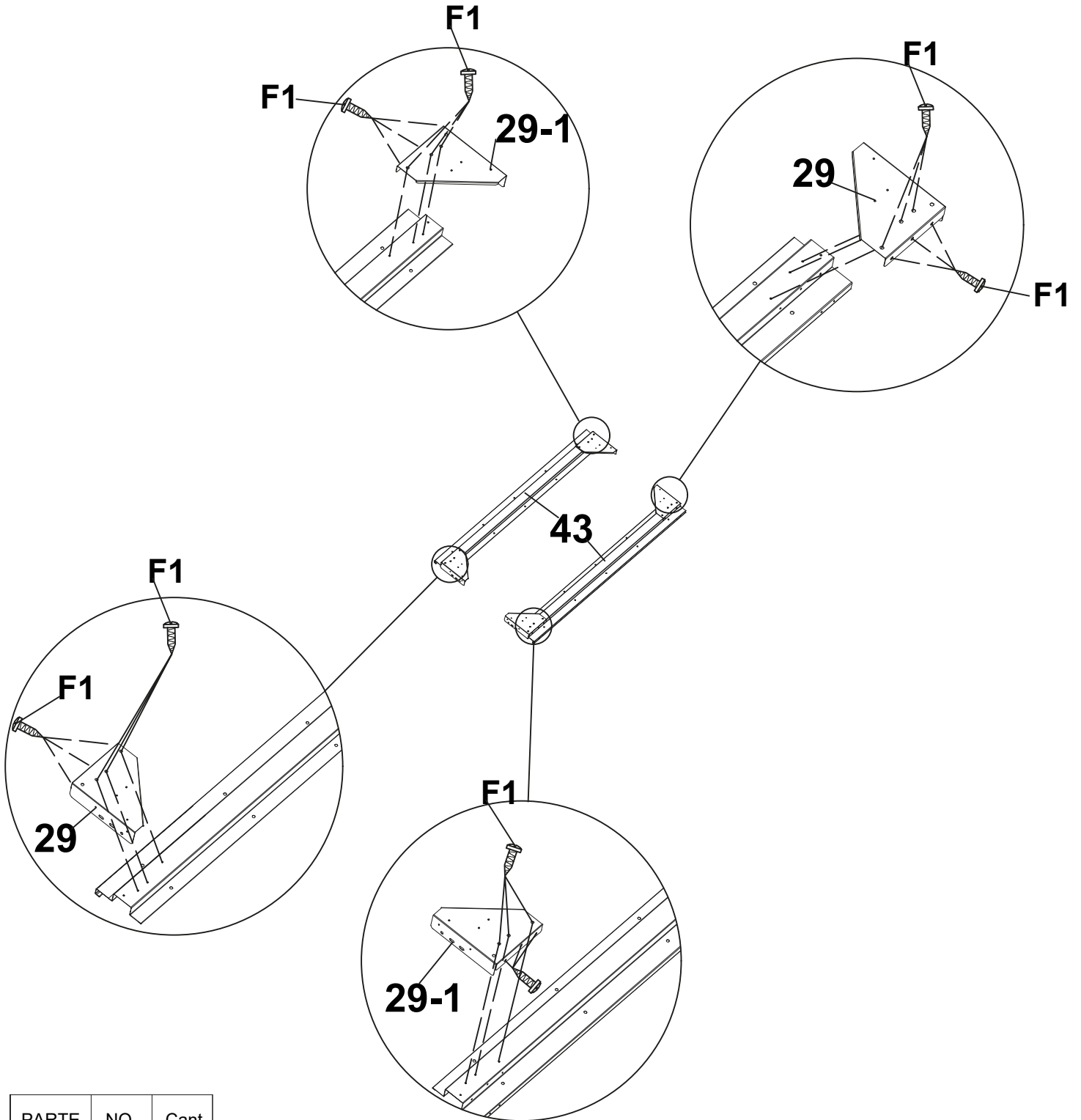

PARTE	NO.	Cant.
	F3	

MONTAJE DE LA PUERTA 7



PARTE	NO.	Cant.
	29	2
	29-1	2
	43	2
	F1	

MONTAJE DE LA PUERTA 8

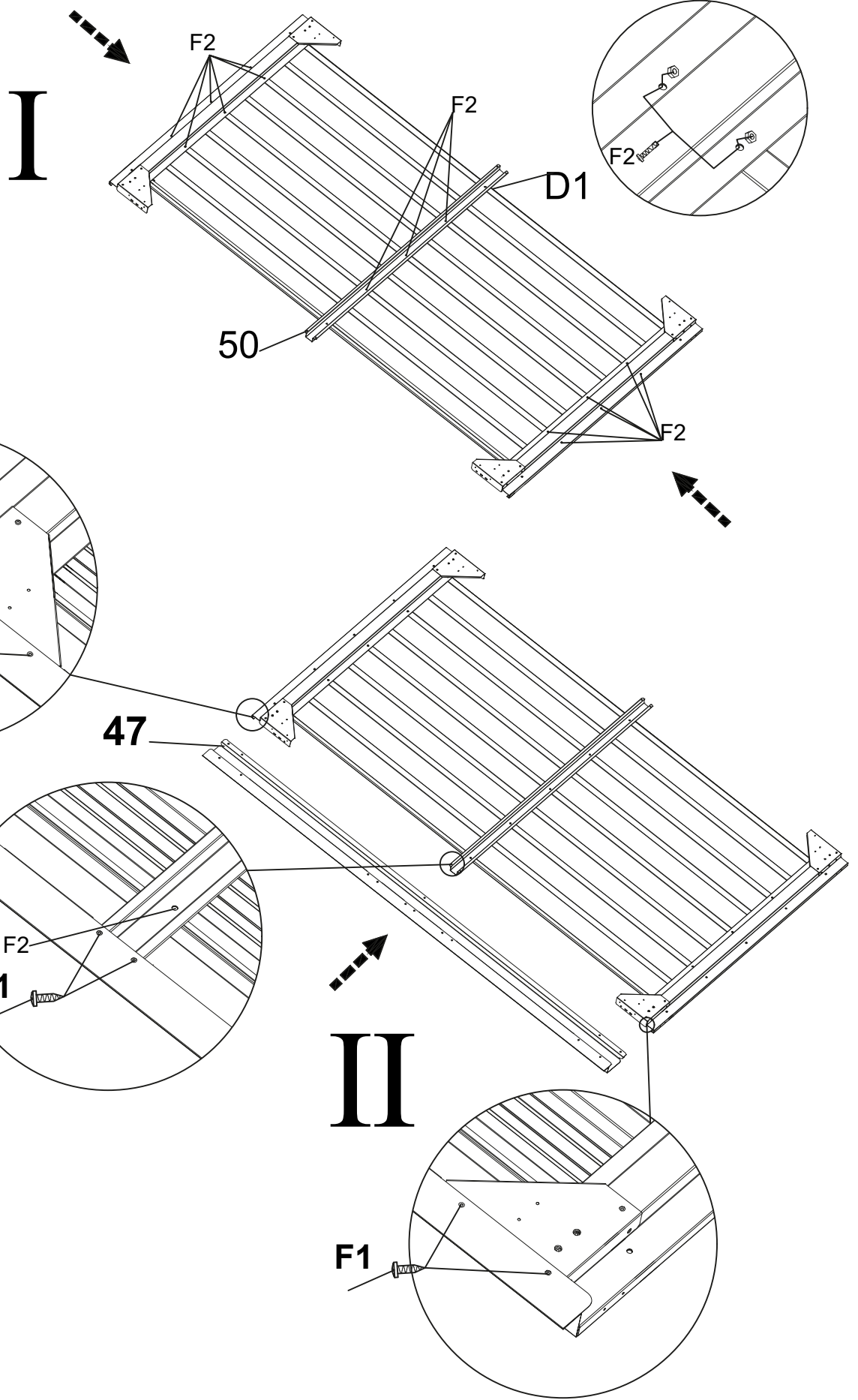



PARTE	NO.	Cant.
	47	1
	50	1
	D1	1
	F2	
	F1	

MONTAJE DE LA PUERTA 9

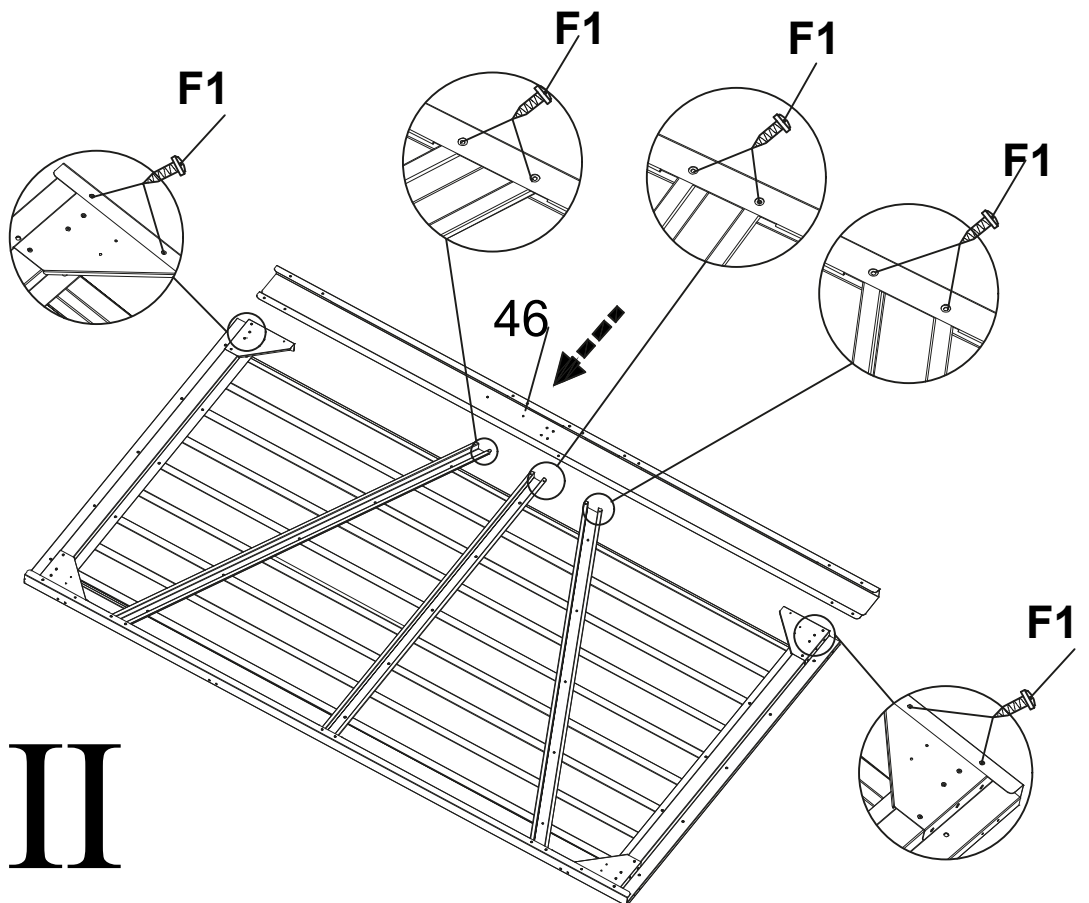
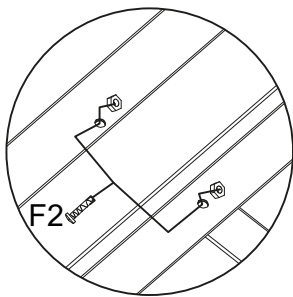
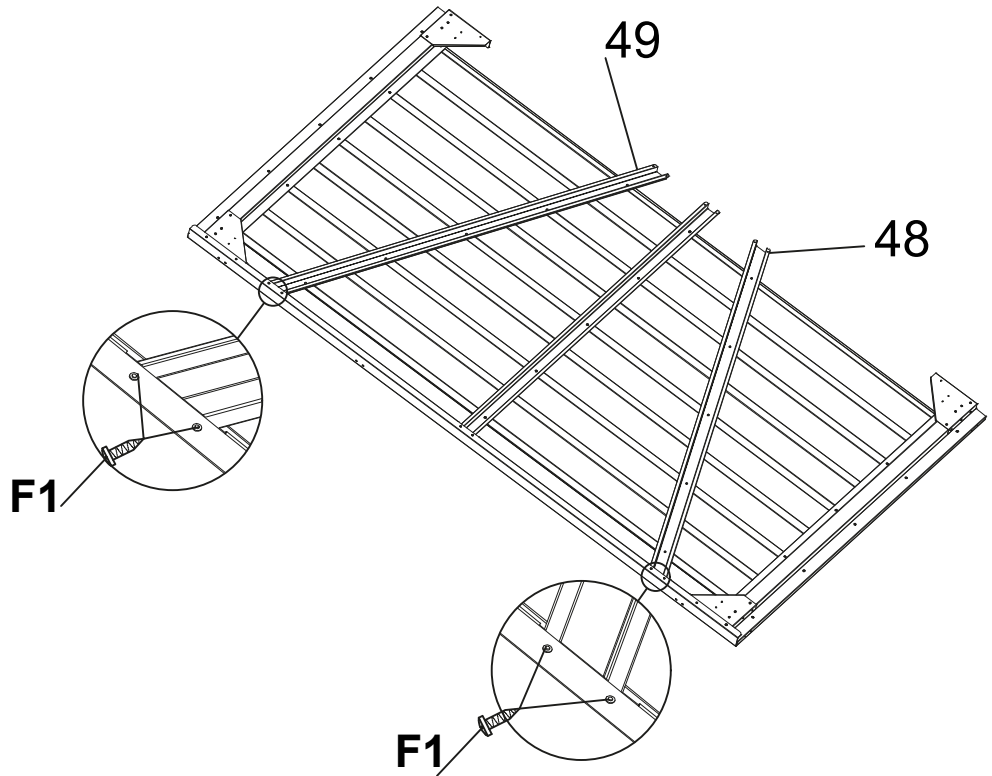
I



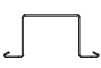
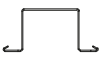

II

PARTE	NO.	Cant.
	48	1
	49	1
	46	1
	F1	

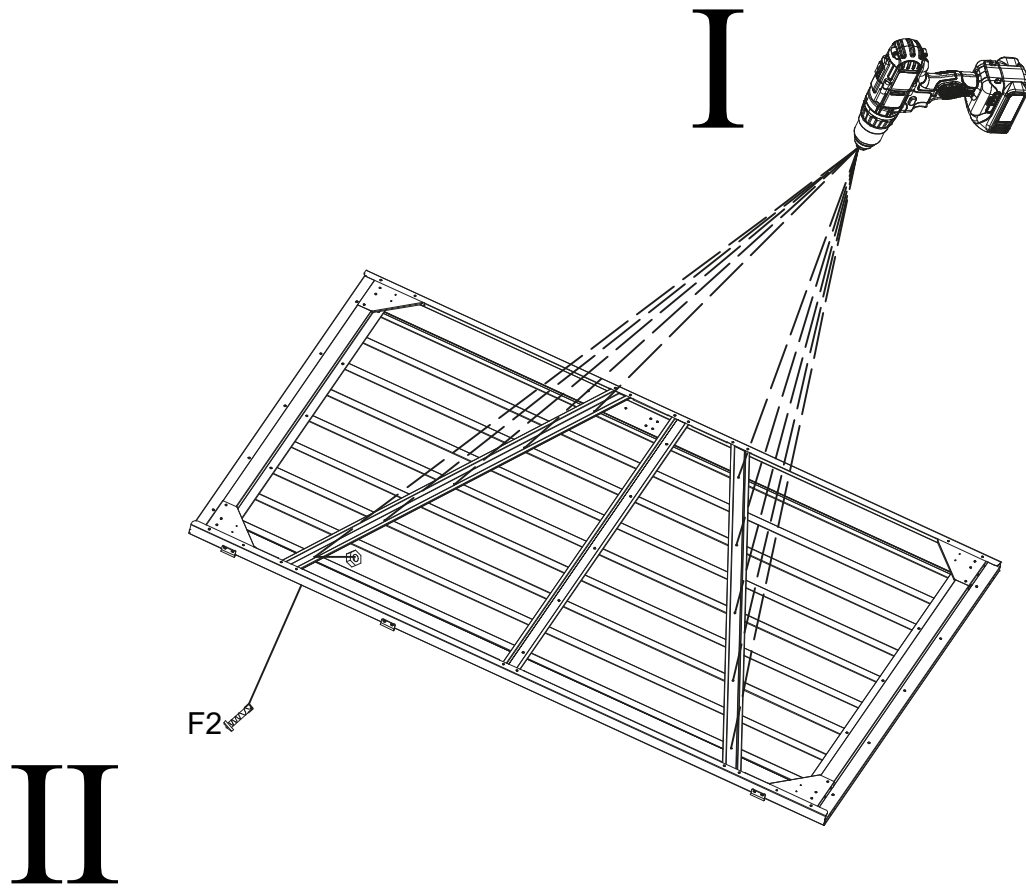
MONTAJE DE LA PUERTA 10





PARTE	NO.	Cant.
	F2	
		

En el frente de la puerta lateral, ensamble (B5) y (H1), (H2) con tornillo (F1).

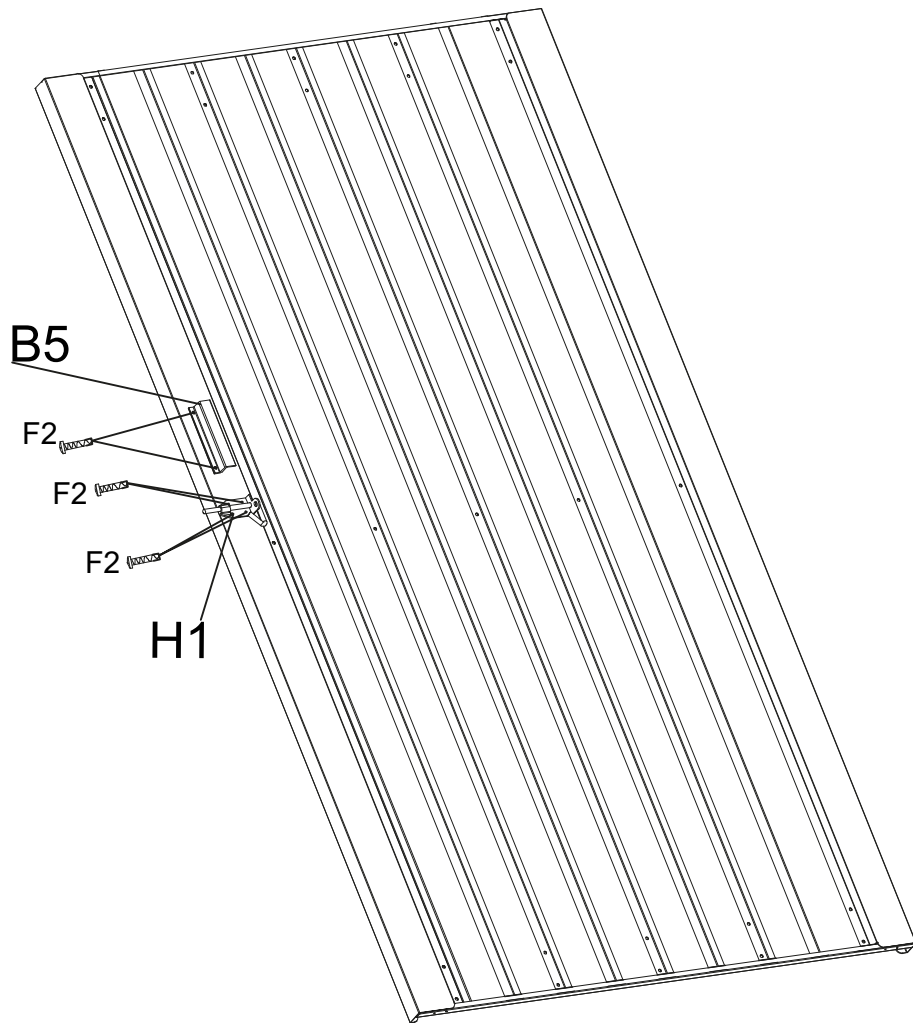
MONTAJE DE LA PUERTA 11



PARTE	NO.	Cant.
	B5	1
	H1	1
	F2	

MONTAJE DE LA PUERTA 12

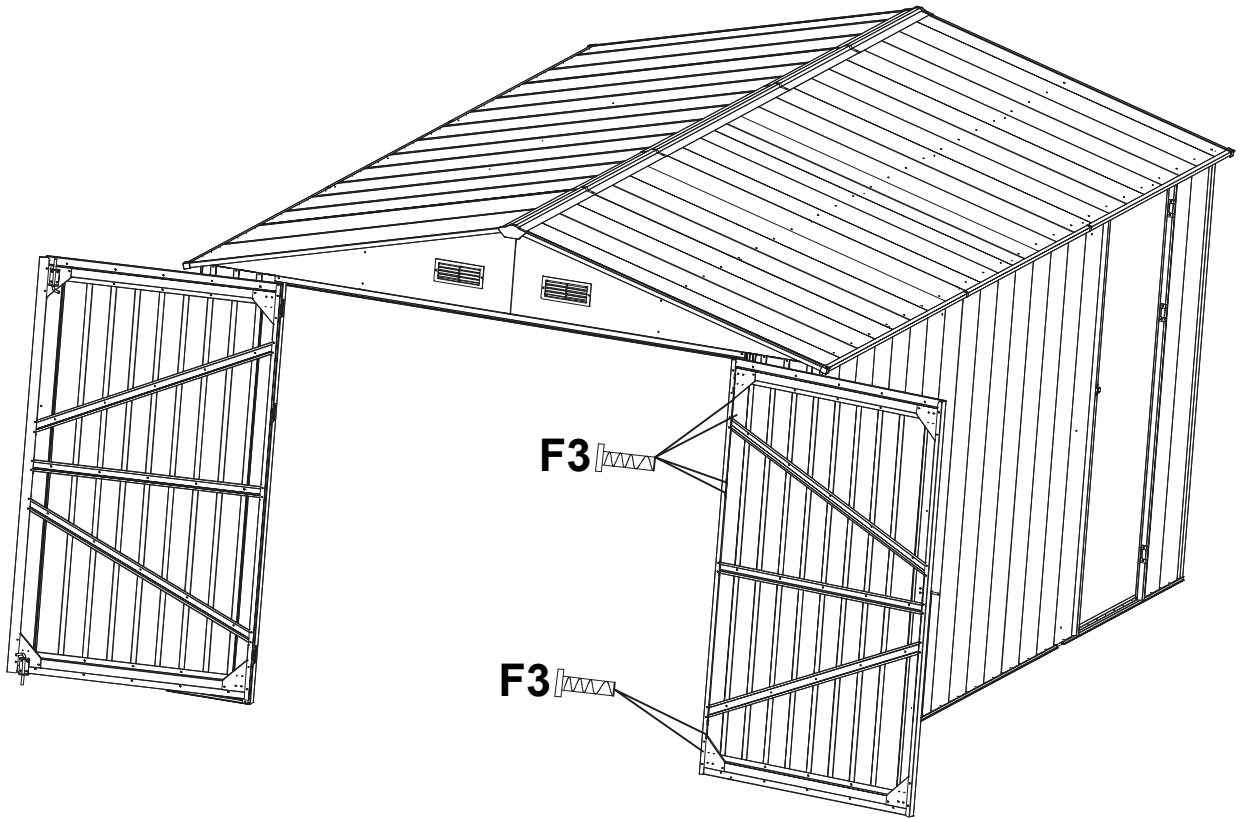

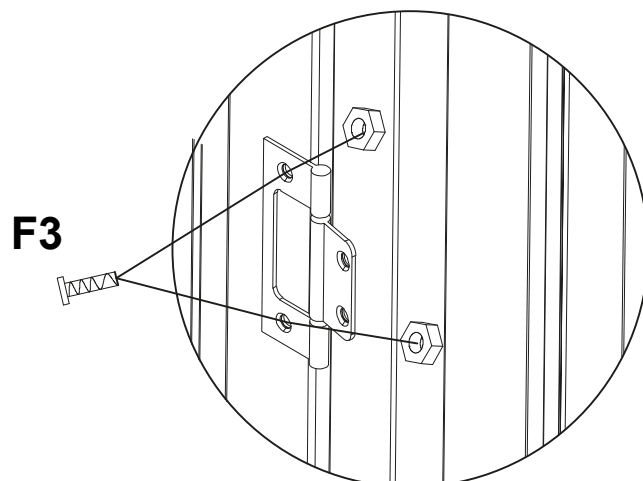

PARTE	NO.	Cant.
 	F3	

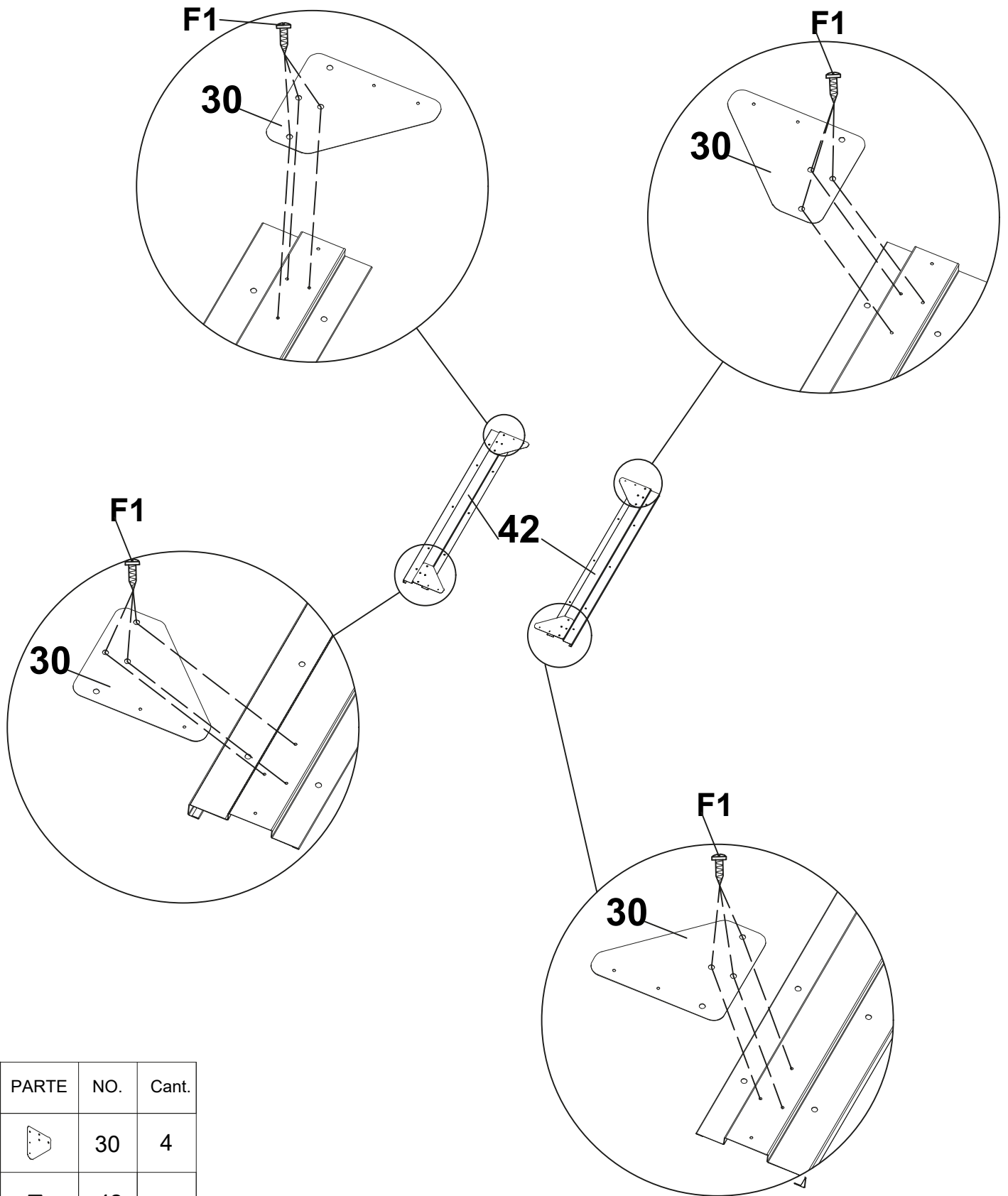

MONTAJE DE LA PUERTA 13





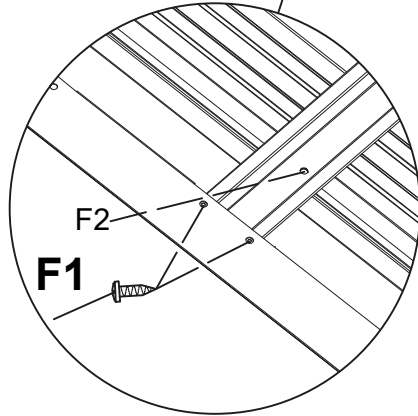
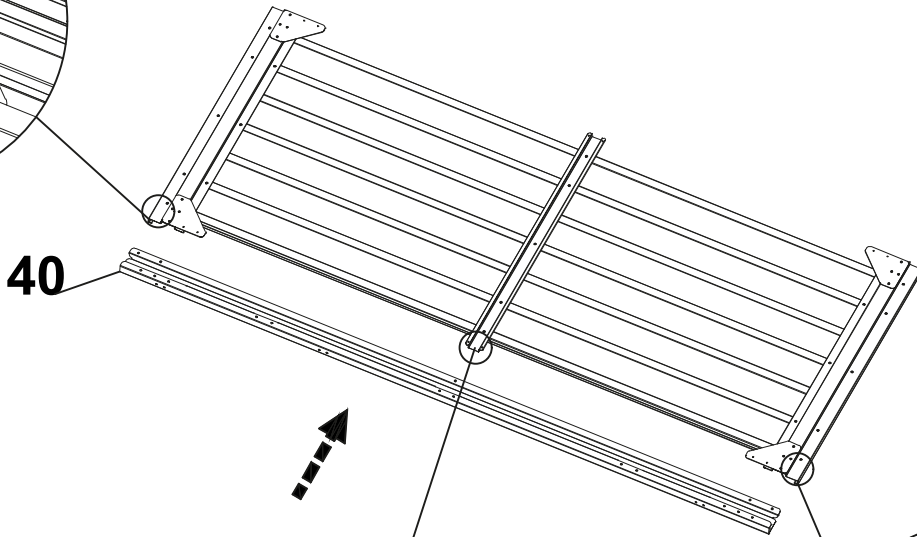
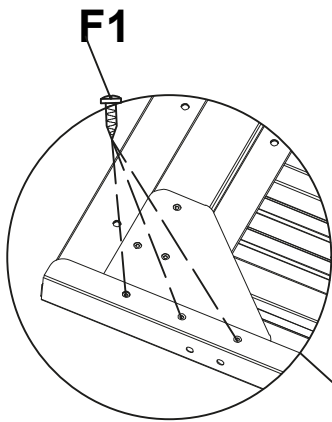
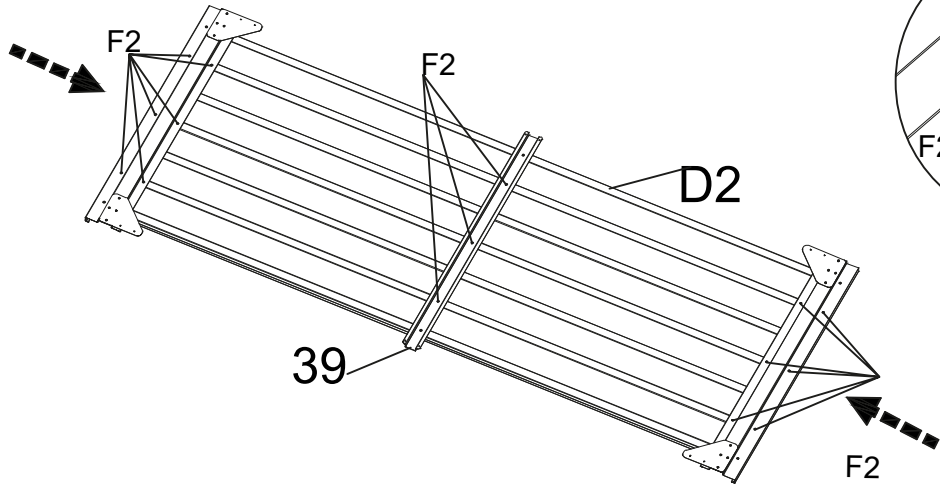

PARTE	NO.	Cant.
	30	4
	42	2
	F1	

MONTAJE DE LA PUERTA 14

I







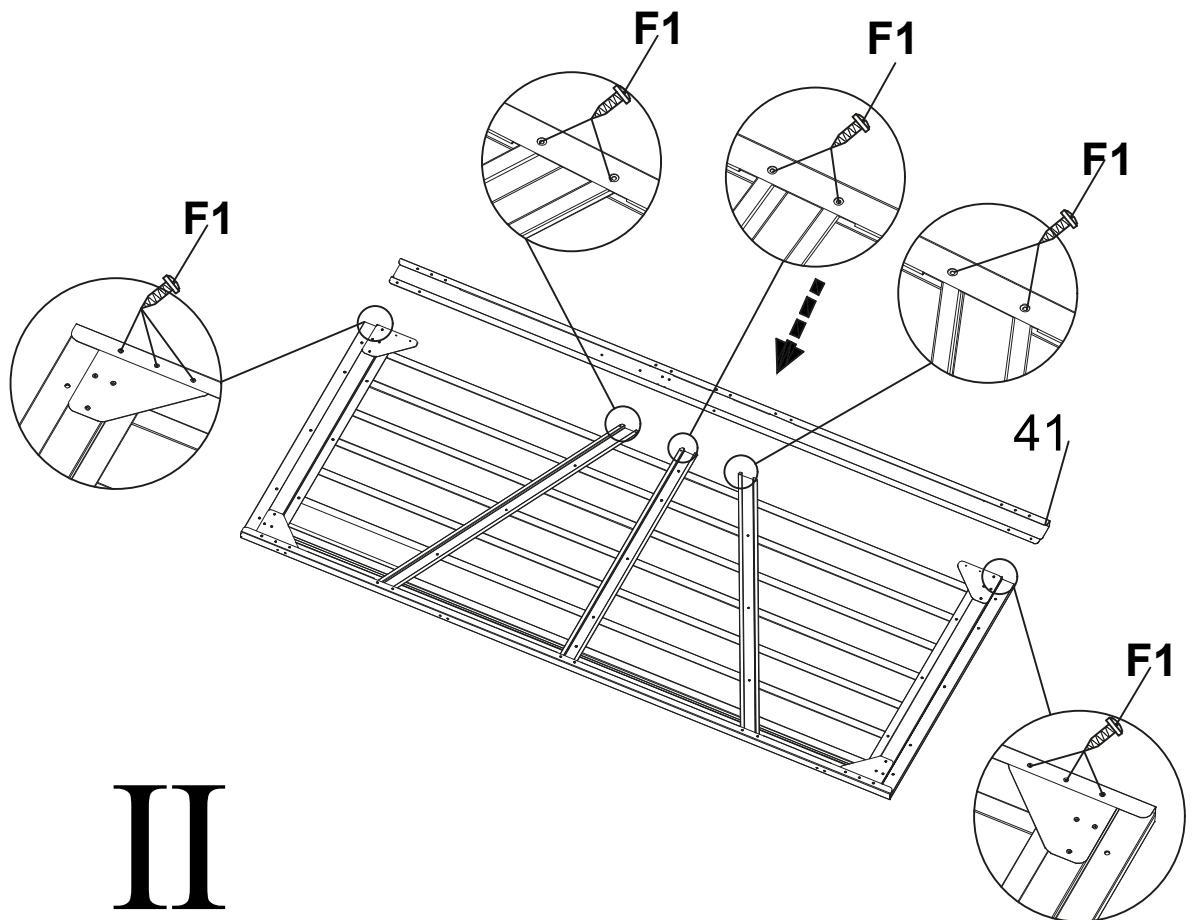
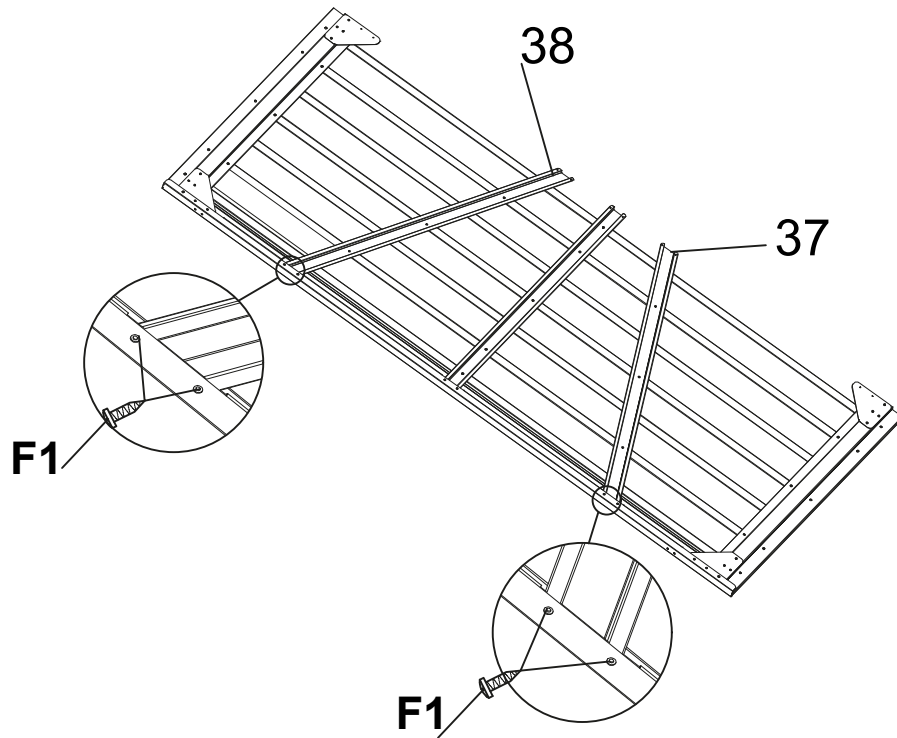

II

PARTE	NO.	Cant.
	40	1
	39	1
	D2	1
	F2	
	F1	

MONTAJE DE LA PUERTA 15

I



PARTE	NO.	Cant.
	37	1
	38	1
	41	1
	F2	
	F1	



II

MONTAJE DE LA PUERTA 16

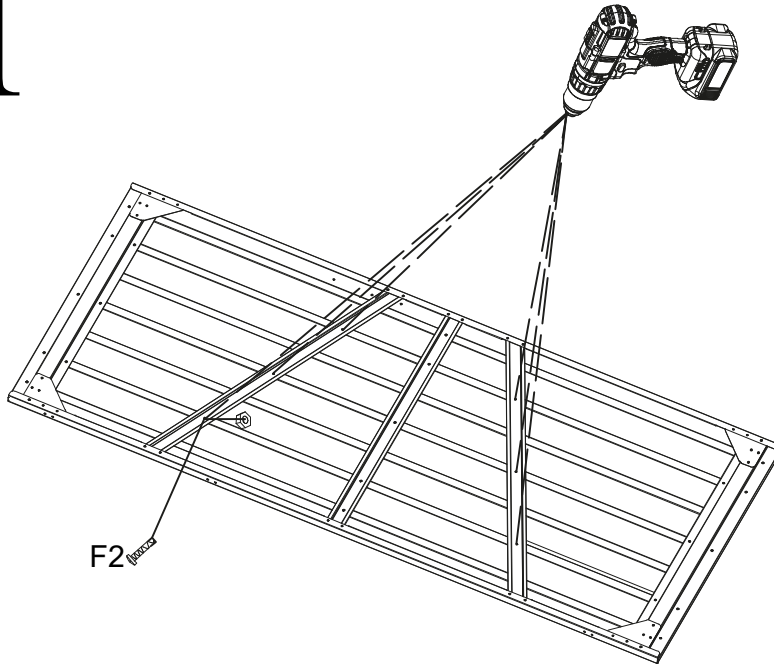
I







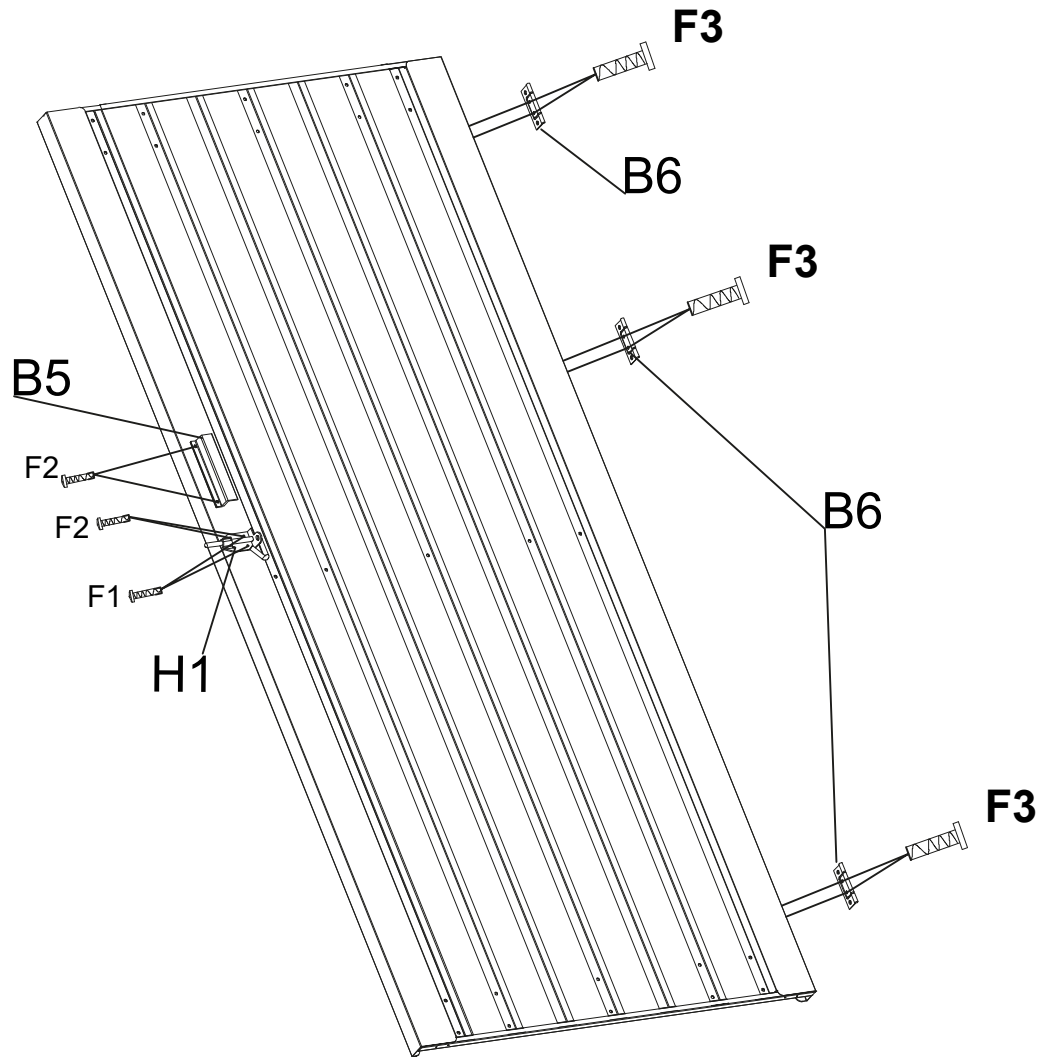

II

PARTE	NO.	Cant.
	F2	
		

MONTAJE DE LA PUERTA 17



PARTE	NO.	Cant.
	B5	1
	B6	3
	H1	1
	F3	
	F2	
	F1	

MONTAJE DE LA PUERTA 18

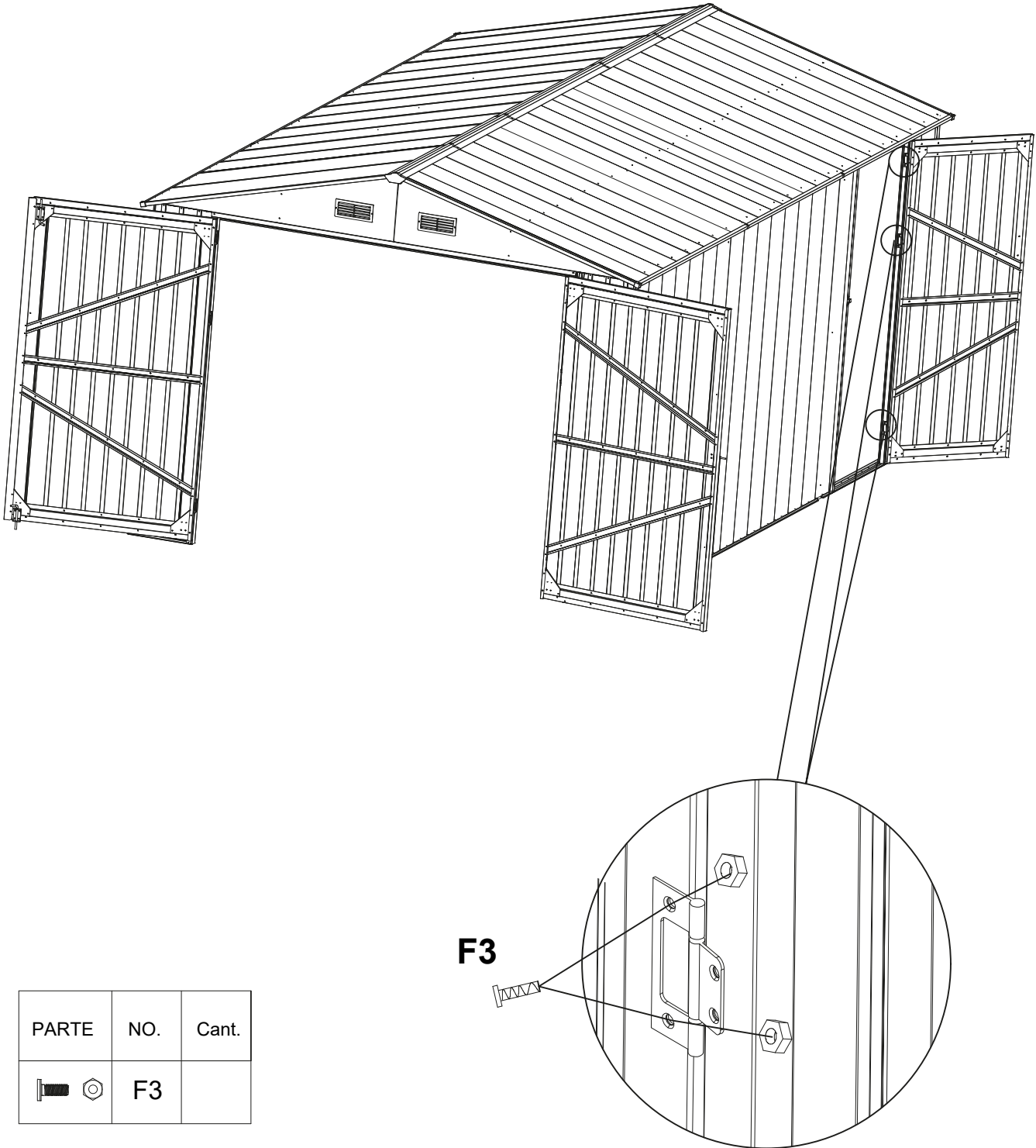

PARTE	NO.	Cant.
 	F3	

